



Service Manual



Table of Contents

Part I : Technical Information	1
1. Summary	1
2. Specifications	5
2.1 Specification Sheet.....	5
2.2 Capacity Variation Ratio According to Temperature	49
2.3 Cooling and Heating Data Sheet in Rated Frequency	54
3. Outline Dimension Diagram	55
3.1 Indoor Unit.....	55
3.2 Outdoor Unit.....	56
4. Refrigerant System Diagram	59
5. Electrical Part	61
5.1 Wiring Diagram.....	61
5.2 PCB Printed Diagram.....	67
6. Function and Control	75
6.1 Remote Controller Introduction.....	75
6.2 GREE+ App Operation Manual.....	93
6.3 Ewpe Smart App Operation Manual	94
6.4 Brief Description of Modes and Functions.....	95
Part II : Installation and Maintenance	104
7. Notes for Installation and Maintenance	104
8. Installation	107
8.1 Installation Dimension Diagram	107
8.2 Installation Parts-checking	109
8.3 Selection of Installation Location.....	109
8.4 Electric Connection Requirement	109
8.5 Installation of Indoor Unit.....	109

Table of Contents

8.6 Installation of Outdoor unit	111
8.7 Test and operation	113
8.8 Leakage Detection	113
8.9 Check after Installation and Test operation.....	113
9. Maintenance	114
9.1 Error Code List.....	114
9.2 Procedure of Troubleshooting.....	118
9.3 Troubleshooting for Normal Malfunction.....	135
10. Exploded View and Parts List	137
10.1 Indoor Unit.....	137
10.2 Outdoor Unit.....	145
11. Removal Procedure	159
11.1 Removal Procedure of Indoor Unit.....	159
11.2 Removal Procedure of Outdoor Unit.....	164
Appendix:	191
Appendix 1: Reference Sheet of Celsius and Fahrenheit	191
Appendix 2: Configuration of Connection Pipe	191
Appendix 3: Pipe Expanding Method.....	192
Appendix 4: List of Resistance for Temperature Sensor	193

1. Summary

Indoor Unit:

B2 panel



B6 panel



C4 panel



C6 panel



D6 panel



D8 panel



A5 panel



B8 panel



D4 panel



1. Summary

Outdoor Unit:

GRHFRT12ASA
GRHFRT12AS

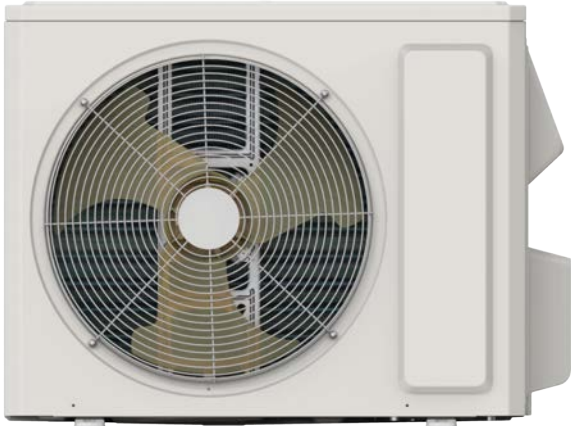

GRHFRT18AS

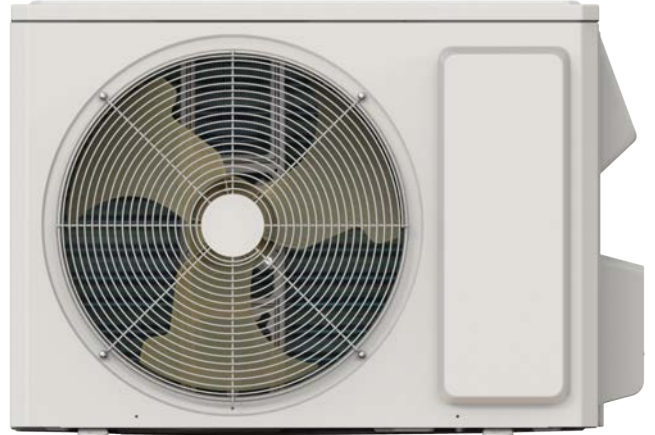

GRHFRT24AS

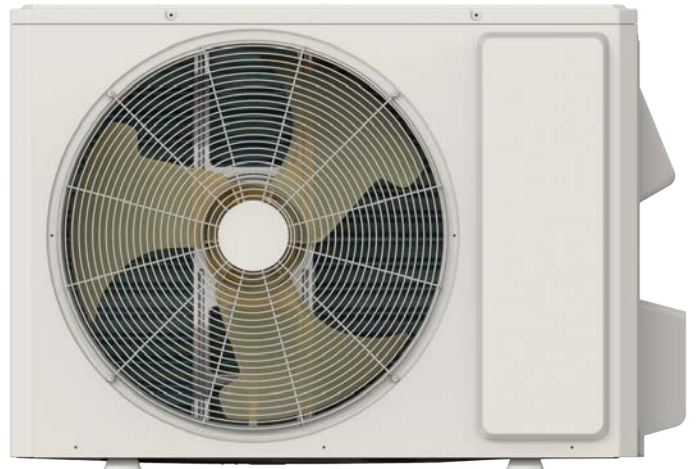

1. Summary

Model list:

No.	Model	Product code	Indoor model	Indoor product code	Outdoor model	Outdoor product code	Remote Controller
1	GWHFRT12SA		GWHFRT12SA		GRHFRT12ASA		YAN1F10F (WiFi)
2	GWHFRT12S		GWHFRT12S		GRHFRT12AS		
3	GWHFRT18S		GWHFRT18SI		GRHFRT18AS		YAY1FF
4	GWHFRT24S		GWHFRT24S		GRHFRT24AS		

1. Summary

Model list:

Remote Controller:



YAY1FF



YAN1F6F(WiFi)

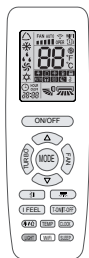

YAP1F7F(WiFi)



YAN1F10F(WiFi)

2. Specifications

Model			GWHFRT12SA / GRHFRT12ASA	GWHFRT12S / GRHFRT12AS
Product Code			CB464008700	CB464008500
Power Supply	Rated Voltage	V~	115	208/230
	Rated Frequency	Hz	60	60
	Phases		1	1
Power Supply Mode			Outdoor	Outdoor
Cooling Capacity		Btu/h	12000	12000
Heating Capacity		Btu/h	12000	12000
Cooling Power Input		W	1062	1062
Heating Power Input		W	992	992
Cooling Power Current		A	11.5	5.0
Heating Power Current		A	10.8	4.8
Rated Input		W	1450	1450
Rated Cooling Current		A	15.8	6.8
Rated Heating Current		A	15.8	7.0
Air Flow Volume		CFM	400/365/330/288/265/247/230	400/365/330/288/265/247/230
Dehumidifying Volume		Pint/h	2.96	2.96
EER		(Btu/h)/W	11.30	11.30
COP		(Btu/h)/W	12.10	12.10
SEER			20(SEER) 20(SEER2)	20(SEER) 20(SEER2)
HSPF			10(HSPF) 8.5(HSPF2)	10(HSPF) 8.5(HSPF2)
Application Area		yd ²	19-29	19-29
Indoor Unit	Model of indoor unit		GWHFRT12SA	GWHFRT12S
	Indoor Unit Product Code		CB464N08700	CB464N08500
	Fan Type		Cross-flo	Cross-flo
	Fan Diameter Length(D×L)		mm	Φ98×633.5
	Cooling Speed		r/min	1400/1200/1120/1050/950/850/750/500
	Heating Speed		r/min	1400/1200/114/1080/1020/960/900
	Fan Motor Power Output		W	20
	Fan Motor RLA		A	0.30
	Fan Motor Capacitor		μF	/
	Evaporator Form			Aluminum Fin-copper Tube
	Evaporator Pipe Diameter		mm	Φ5
	Evaporator Row-fin Ga		mm	2-1.4
	Evaporator Coil Length (L×D×W)		mm	635×22.8×306.3
	Swing Motor Model			MP24HF
	Swing Motor Power Output		W	1.5
	Fuse Current		A	3.15
	Sound Pressure Level		dB (A)	Cooling: 44/39/37/35/32/30/27 Heating: 45/39/38/36/34/32/31
	Sound Power Level		dB (A)	Cooling: 54/49/47/45/42/40/37 Heating: 55/49/48/46/44/42/41
	Dimension (W×H×D)		inch	33 17/64×11 3/8×8 15/64
	Dimension of Carton Box (L×W×H)		inch	35 7/16×13 13/16×10 45/64
Dimension of Package (L×W×H)		inch	35 5/8×14 29/64×11 9/64	
Net Weight		lb	22.1	
Gross Weight		lb	26.5	

2. Specifications

		GRHFRT12ASA	GRHFRT12AS
Outdoor Unit	Outdoor Unit Model		
	Outdoor Unit Product Code	CB464W08700	CB464W08500
	Compressor Manufacturer	ZHUHAI LANDA COMPRESSOR CO.,LTD	ZHUHAI LANDA COMPRESSOR CO.,LTD
	Compressor Model	FTz-AN108ACBD	FTz-AN108ACBD
	Compressor Oil	FW68DA or equivalent	FW68DA or equivalent
	Compressor Type	Rotary	Rotary
	Compressor LRA	A	/
	Compressor RLA	A	15.40
	Compressor Power Input	W	857
	Compressor Overload Protector		/
	Throttling Method		Electron expansion valve
	Set Temperature Range	°F	61~86
	Cooling Operation Ambient Temperature Range	°F	0~115
	Heating Operation Ambient Temperature Range	°F	-4~75
	Condenser Form		Aluminum Fin-copper Tube
	Condenser Pipe Diameter	mm	Φ7
	Condenser Rows-fin Ga	mm	2-1.4
	Condenser Coil Length (L×D×W)	mm	700×38.1×528
	Fan Motor Speed	rpm	900
	Fan Motor Power Output	W	30
	Fan Motor RLA	A	0.90
	Fan Motor Capacitor	μF	/
	Outdoor Unit Air Flow Volume	CFM	1148
	Fan Type		Axial-flo
	Fan Diameter	mm	Φ400
	Defrosting Method		Automatic Defrosting
	Climate Type		T1
	Isolation		I
	Moisture Protection		IPX4
	Permissible Excessive Operating Pressure for the Discharge Side	MPa	4.3
	Permissible Excessive Operating Pressure for the Suction Side	MPa	2.5
	Sound Pressure Level	dB (A)	52
	Sound Power Level	dB (A)	62
Dimension (W×H×D)	inch	28 13/16×21 27/32×12 63/64	
Dimension of Carton Box (L×W×H)	inch	31 9/64×14 11/16×23 15/64	
Dimension of Package (L×W×H)	inch	31 17/64×14 51/64×24 7/32	
Net Weight	lb	65.1	
Gross Weight	lb	70.6	
Refrigerant		R410A	
Refrigerant Charge	oz	34.6	
Connection Pipe	Connection Pipe Length	ft	24.6
	Connection Pipe Gas Additional Charge	oz/ft	0.2
	Outer Diameter Liquid Pipe	inch	1/4"
	Outer Diameter Gas Pipe	inch	3/8"
	Max Distance Height	ft	32.8
	Max Distance Length	ft	65.6
	Note: The connection pipe applies metric diameter.		

The above data is subject to change without notice. Please refer to the nameplate of the unit.

2. Specifications

Model			GWHFRT18S / GRHFRT18AS
Product Code			1.CB425020900 2.CB444016000 3.CB443013900 4.CB432032200 5.CB438016000 6.CB435018000
Power Supply	Rated Voltage	V~	208/230
	Rated Frequency	Hz	60
	Phases		1
Power Supply Mode			Outdoor
Cooling Capacity		Btu/h	17400
Heating Capacity		Btu/h	19100
Cooling Power Input		W	1820
Heating Power Input		W	1866
Cooling Power Current		A	8.1
Heating Power Current		A	8.2
Rated Input		W	2300
Rated Cooling Current		A	9.5
Rated Heating Current		A	9.5
Air Flow Volume		CFM	471//436/406/374/335/312/277
Dehumidifying Volume		Pint/h	3.8
EER		(Btu/h)/W	9.55
COP		(Btu/h)/W	10.24
SEER			16.5
HSPF			9
Application Area		yd ²	28-41
Indoor Unit	Model of indoor unit		GWHFRT18S
	Indoor Unit Product Code		1.CB425N20900 2.CB444N16000 3.CB443N13900 4.CB432N32200 5.CB438N16000 6.CB435N18000
	Fan Type		Cross-flo
	Fan Diameter Length(D×L)		mm Φ106×706
	Cooling Speed		r/min 1350/1280/1200/1130/1050/980/900
	Heating Speed		r/min 1350/1280/1200/1130/1050/980/900
	Fan Motor Power Output		W 35
	Fan Motor RLA		A 0.3
	Fan Motor Capacitor		μF 2.5
	Evaporator Form		Aluminum Fin-copper Tube
	Evaporator Pipe Diameter		mm Φ7
	Evaporator Row-fin Ga		mm 2-1.4
	Evaporator Coil Length (L×D×W)		mm 715×25.4×304.8
	Swing Motor Model		MP35CJ
	Swing Motor Power Output		W 2.5
	Fuse Current		A 3.15
	Sound Pressure Level		dB (A) Cooling: 47/45/42/41/38/36/34 Heating: 48/45/43/41/38/36/34
	Sound Power Level		dB (A) Cooling: 57/55/52/51/48/46/44 Heating: 58/55/53/51/48/46/44
	Dimension (W×H×D)		inch 38 3/16×11 13/16×8 55/64
	Dimension of Carton Box (L×W×H)		inch 40 5/32×14 9/16×11 37/64
Dimension of Package (L×W×H)		inch 40 23/64×14 7/8×11 31/32	
Net Weight		lb 29.8(C4/C6/B2/B8 Panel) / 30.9(A5 Panel)	
Gross Weight		lb 35.3(C4/C6/B2/B8 Panel) / 36.4(A5 Panel)	

2. Specifications

Outdoor Unit	Outdoor Unit Model		GRHFRT18AS	
	Outdoor Unit Product Code		CB444W16000	
	Compressor Manufacturer		ZHUHAI LANDA COMPRESSOR CO. LTD.	
	Compressor Model		QXF-A139zH170A	
	Compressor Oil		FW68DA or equivalent	
	Compressor Type		Rotary	
	Compressor LRA.	A		25.0
	Compressor RLA	A		9.35
	Compressor Power Input	W		1295
	Compressor Overload Protector			/
	Throttling Method			Capillary
	Set Temperature Range	°F		61~86
	Cooling Operation Ambient Temperature Range	°F		0~115
	Heating Operation Ambient Temperature Range	°F		19~75
	Condenser Form			Aluminum Fin-copper Tube
	Condenser Pipe Diameter	mm		Φ7
	Condenser Rows-fin Ga	mm		2-1.4
	Condenser Coil Length (L×D×W)	mm		780×23×514
	Fan Motor Speed	rpm		900
	Fan Motor Power Output	W		30
	Fan Motor RLA	A		0.5
	Fan Motor Capacitor	μF		/
	Outdoor Unit Air Flow Volume	CFM		1177
	Fan Type			Axial-flo
	Fan Diameter	mm		Φ420
	Defrosting Method			Automatic Defrosting
	Climate Type			T1
	Isolation			I
	Moisture Protection			IPX4
	Permissible Excessive Operating Pressure for the Discharge Side	MPa		4.3
	Permissible Excessive Operating Pressure for the Suction Side	MPa		2.5
	Sound Pressure Level	dB (A)		57
	Sound Power Level	dB (A)		67
Dimension (W×H×D)	inch		31 37/64×21 27/32×13 25/32	
Dimension of Carton Box (L×W×H)	inch		34 7/32×15 35/64×23 25/64	
Dimension of Package (L×W×H)	inch		34 21/64×15 43/64×24 13/32	
Net Weight	lb		69.5	
Gross Weight	lb		75.0	
Refrigerant			R410A	
Refrigerant Charge	oz		42.4	
Connection Pipe	Connection Pipe Length	ft	24.6	
	Connection Pipe Gas Additional Charge	oz/ft	0.17	
	Outer Diameter Liquid Pipe	inch	1/4"	
	Outer Diameter Gas Pipe	inch	1/2"	
	Max Distance Height	ft	32.8	
	Max Distance Length	ft	82.0	
	Note: The connection pipe applies metric diameter.			

The above data is subject to change without notice. Please refer to the nameplate of the unit.

2. Specifications

Model			GWHFRT24S / GRHFRT24AS
Product Code			1.CB425020300 2.CB443013500 3.CB444015900 4.CB435017000 5.CB432031900 6.CB438015800
Power Supply	Rated Voltage	V~	208/230
	Rated Frequency	Hz	60
	Phases		1
Power Supply Mode			Outdoor
Cooling Capacity		Btu/h	22000
Heating Capacity		Btu/h	24000
Cooling Power Input		W	1896
Heating Power Input		W	2051
Cooling Power Current		A	8.5
Heating Power Current		A	9.5
Rated Input		W	2500
Rated Cooling Current		A	11
Rated Heating Current		A	12
Air Flow Volume		CFM	677/588/559/500/471/441/412
Dehumidifying Volume		Pint/h	5.28
EER		(Btu/h)/W	11.30
COP		(Btu/h)/W	11.70
SEER			18
HSPF			10
Application Area		yd ²	28-41
Indoor Unit	Model of indoor unit		GWHFRT24S
	Indoor Unit Product Code		1.CB425N20300 2.CB443N13500 3.CB444N15900 4.CB435N17000 5.CB432N31900 6.CB438N15800
	Fan Type		Cross-flo
	Fan Diameter Length(D×L)		mm Φ108×830
	Cooling Speed		r/min 1300/1150/1100/1000/950/900/850
	Heating Speed		r/min 1300/1200/1100/1050/1000/950/900
	Fan Motor Power Output		W 60
	Fan Motor RLA		A 0.30
	Fan Motor Capacitor		μF /
	Evaporator Form		Aluminum Fin-copper Tube
	Evaporator Pipe Diameter		mm Φ7
	Evaporator Row-fin Ga		mm 2-1.4
	Evaporator Coil Length (L×D×W)		mm 850×25.4×342.9
	Swing Motor Model		MP35CJ
	Swing Motor Power Output		W 2.5
	Fuse Current		A 3.15
	Sound Pressure Level		dB (A) Cooling: 51/46/45/42/40/38/37 Heating: 51/48/45/43/42/40/38
	Sound Power Level		dB (A) Cooling: 61/56/55/52/50/48/47 Heating: 61/58/55/53/52/50/48
	Dimension (W×H×D)		inch 42 28/64×12 51/64×9 44/64
	Dimension of Carton Box (L×W×H)		inch 44 16/64×15 48/64×12 61/64
	Dimension of Package (L×W×H)		inch 44 29/64×16 4/64×13 22/64
Net Weight		lb 36.4	
Gross Weight		lb 43.0	

2. Specifications

Outdoor Unit	Outdoor Unit Model		GRHFRT24AS	
	Outdoor Unit Product Code		CB444W15900	
	Compressor Manufacturer		ZHUHAI LANDA COMPRESSOR CO. LTD.	
	Compressor Model		FTz-SM151AXB	
	Compressor Oil		FW68DA or equivalent	
	Compressor Type		Rotary	
	Compressor LRA	A		35.00
	Compressor RLA	A		10.39
	Compressor Power Input	W		1330
	Compressor Overload Protector			HPC 115/95U1 KSD115°C
	Throttling Method			Electron expansion valve
	Set Temperature Range	°F		61~86
	Cooling Operation Ambient Temperature Range	°F		0~122
	Heating Operation Ambient Temperature Range	°F		19.4~75.2
	Condenser Form			Aluminum Fin-copper Tube
	Condenser Pipe Diameter	mm		Φ7
	Condenser Rows-fin Ga	mm		2-1.4
	Condenser Coil Length (L×D×W)	mm		839×38.1×616
	Fan Motor Speed	rpm		880
	Fan Motor Power Output	W		60
	Fan Motor RLA	A		0.73
	Fan Motor Capacitor	μF		3.5
	Outdoor Unit Air Flow Volume	CFM		1883
	Fan Type			Axial-flo
	Fan Diameter	mm		Φ520
	Defrosting Method			Automatic Defrosting
	Climate Type			T1
	Isolation			I
	Moisture Protection			IPX4
	Permissible Excessive Operating Pressure for the Discharge Side	MPa		4.3
	Permissible Excessive Operating Pressure for the Suction Side	MPa		2.5
	Sound Pressure Level	dB (A)		57
	Sound Power Level	dB (A)		67
	Dimension (W×H×D)	inch		37 46/64×25 63/64×15 53/64
Dimension of Carton Box (L×W×H)	inch		40 33/64×17 53/64×28 10/64	
Dimension of Package (L×W×H)	inch		40 40/64×17 61/64×29 1/64	
Net Weight	lb		97.0	
Gross Weight	lb		106.9	
Refrigerant			R410A	
Refrigerant Charge	oz		52.9	
Connection Pipe	Connection Pipe Length	ft	24.6	
	Connection Pipe Gas Additional Charge	oz/ft	0.5	
	Outer Diameter Liquid Pipe	inch	1/4"	
	Outer Diameter Gas Pipe	inch	5/8"	
	Max Distance Height	ft	32.8	
	Max Distance Length	ft	82.0	
	Note: The connection pipe applies metric diameter.			

The above data is subject to change without notice. Please refer to the nameplate of the unit.

2. Specifications

2.2 Capacity Variation Ratio According to Temperature

09K(QB):

Cooling operation ambient temperature range is 0°F~118°F or 0°F~115°F.

Heating operation ambient temperature range is -4°F~75°F.

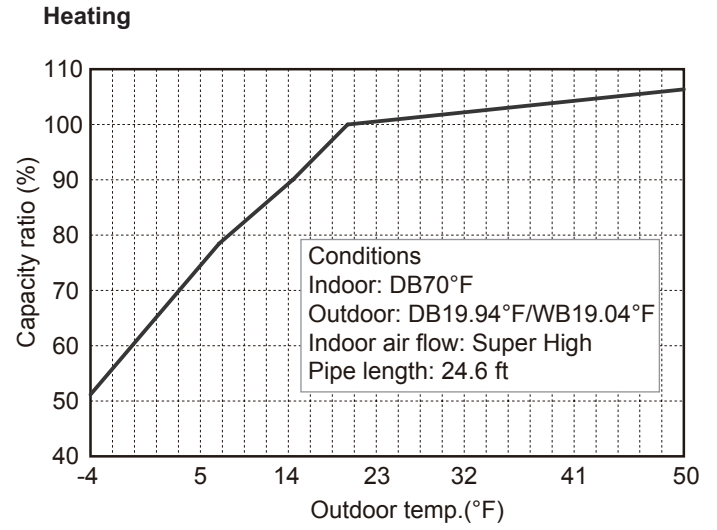
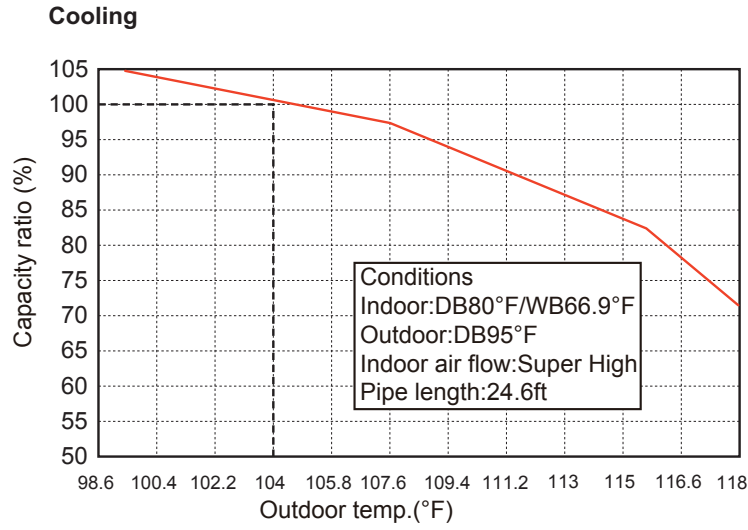

2. Specifications

09K(QC):

Cooling operation ambient temperature range is -20°F~122°F or -4°F~122°F.

Heating operation ambient temperature range is -22°F~86°F.

Cooling

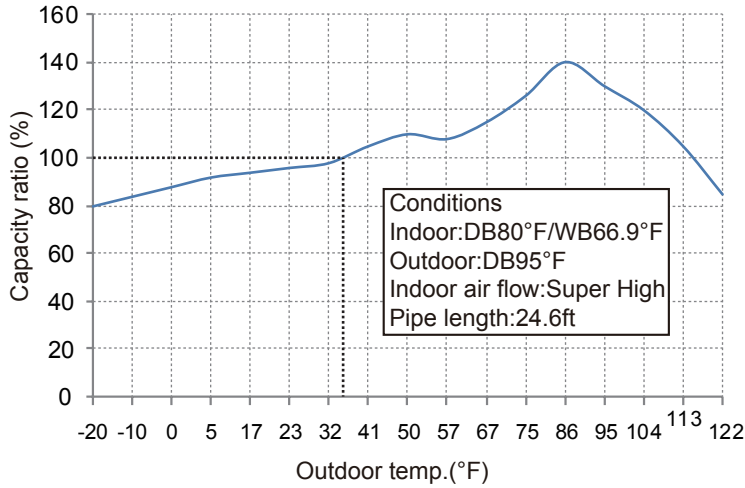

Heating

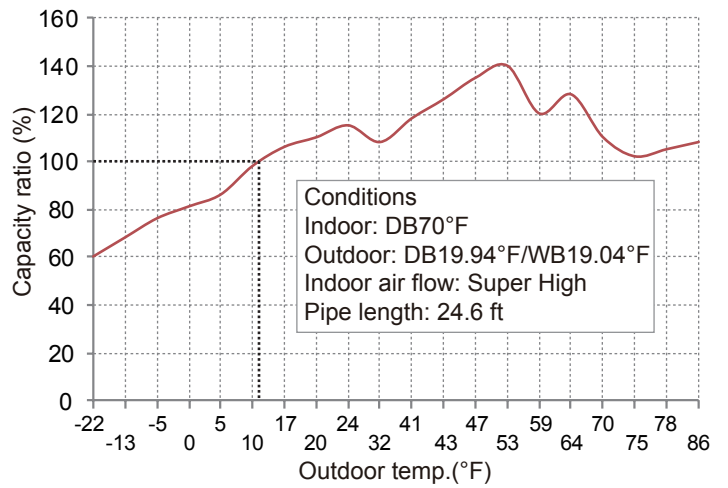

Cooling operation ambient temperature range is 0°F~115°F.

Heating operation ambient temperature range is -4°F~75°F.

Cooling

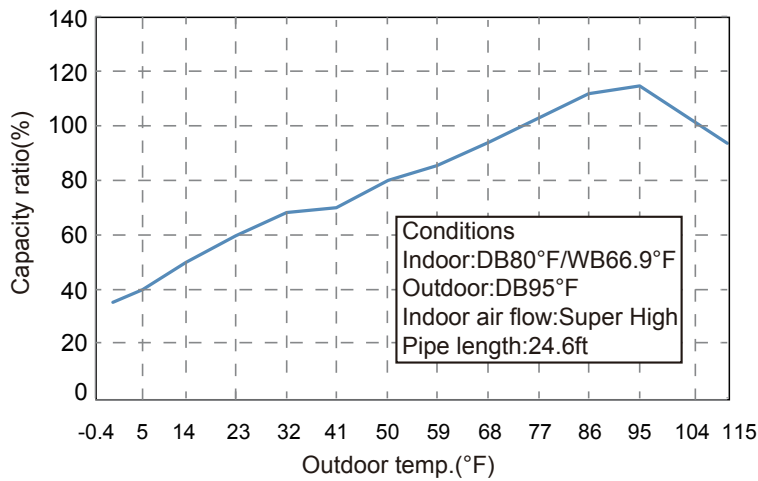

Heating

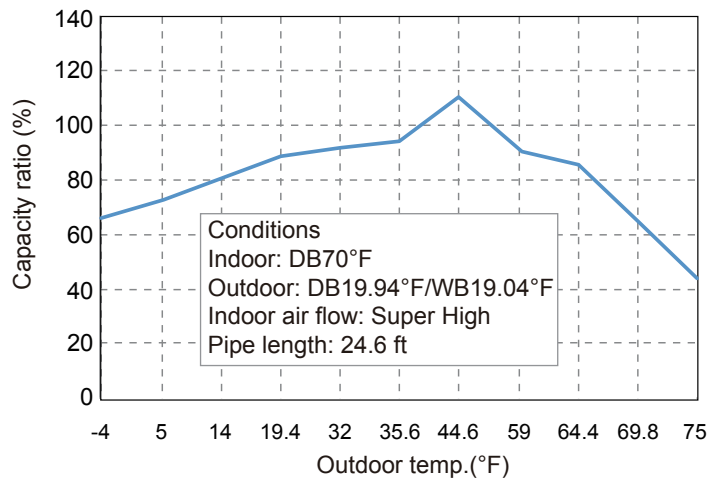

2. Specifications

12K:

Cooling operation ambient temperature range is 0°F~115°F.

Heating operation ambient temperature range is -4°F~75°F.

Cooling

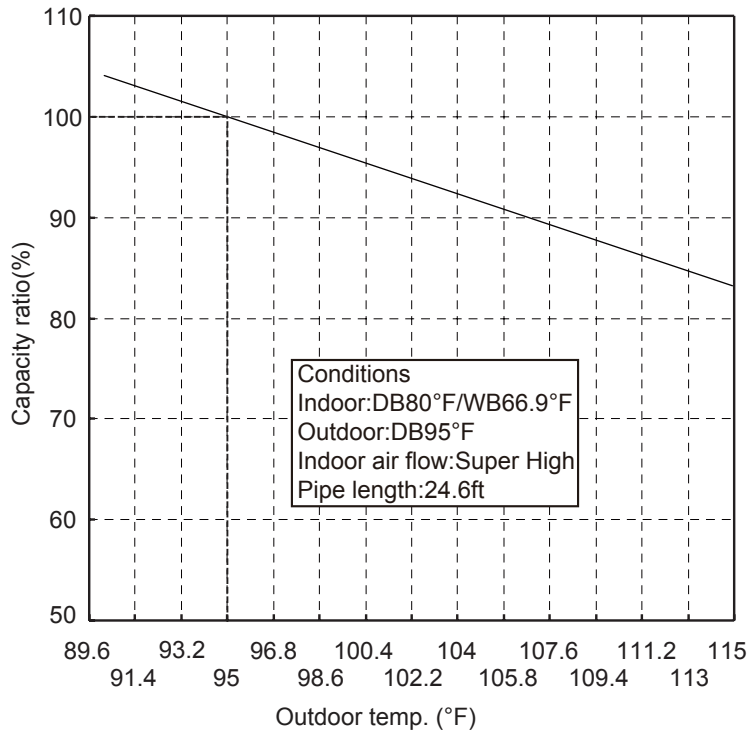

Heating

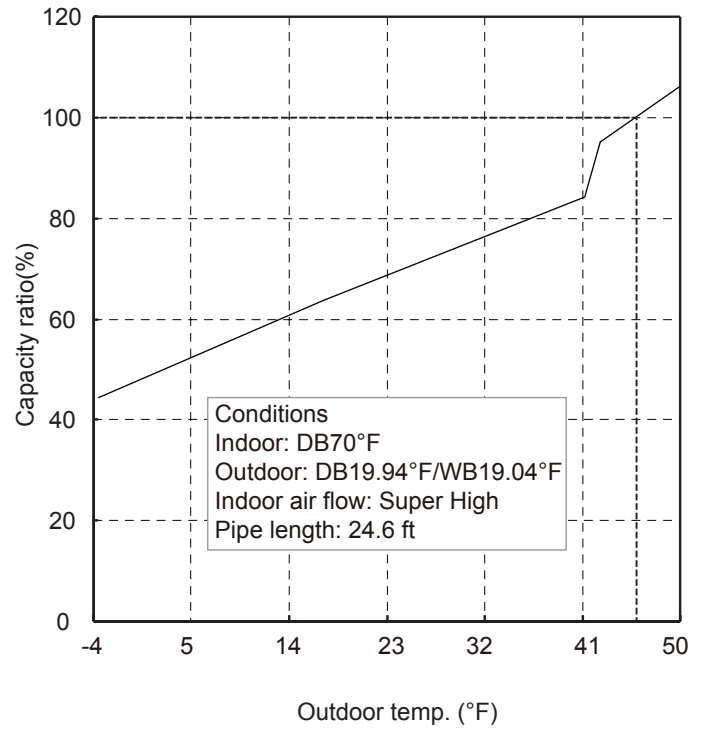

Cooling operation ambient temperature range is -20°F~122°F or -4°F~122°F.

Heating operation ambient temperature range is -22°F~86°F.

Cooling

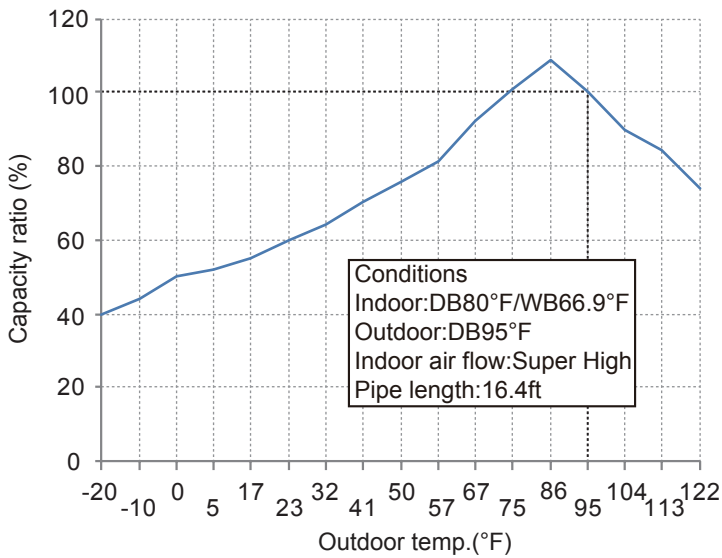

Heating

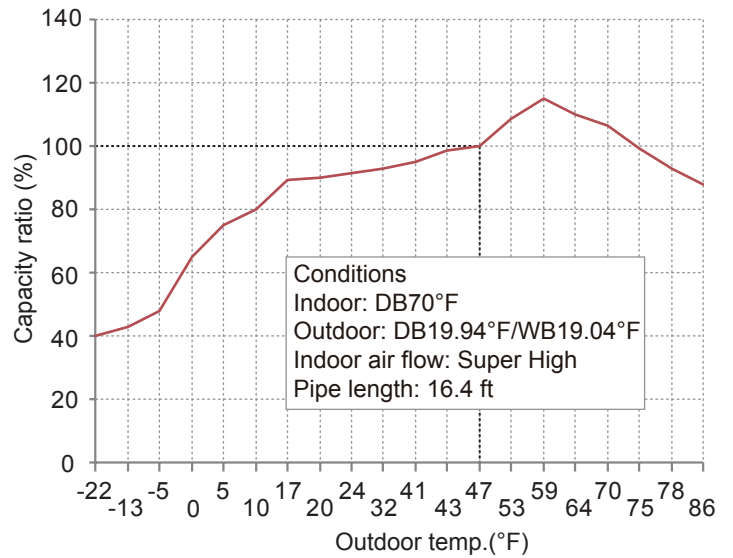

2. Specifications

18K:

Cooling operation ambient temperature range is 0°F~115°F.
 Heating operation ambient temperature range is 19°F~75°F.

Cooling

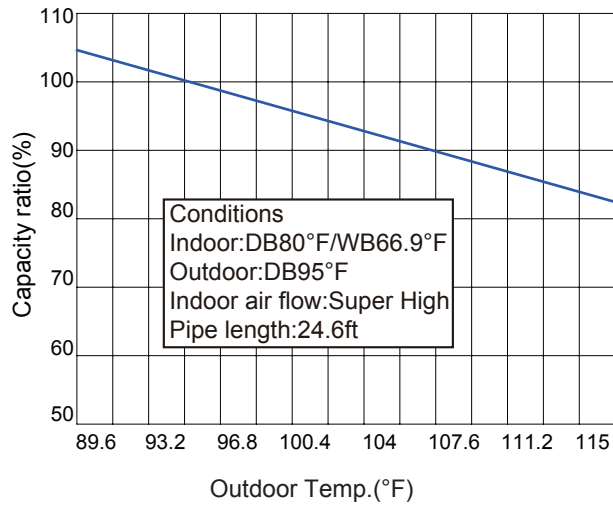

Heating

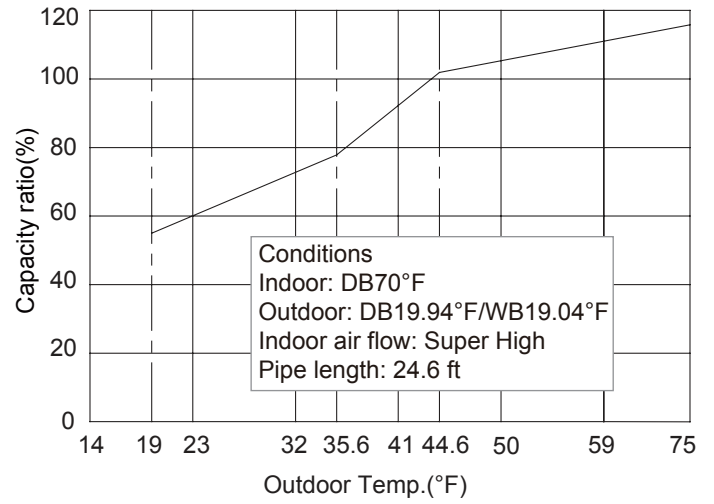

Cooling operation ambient temperature range is 0°F~115°F.
 Heating operation ambient temperature range is -13°F~75°F.

Cooling

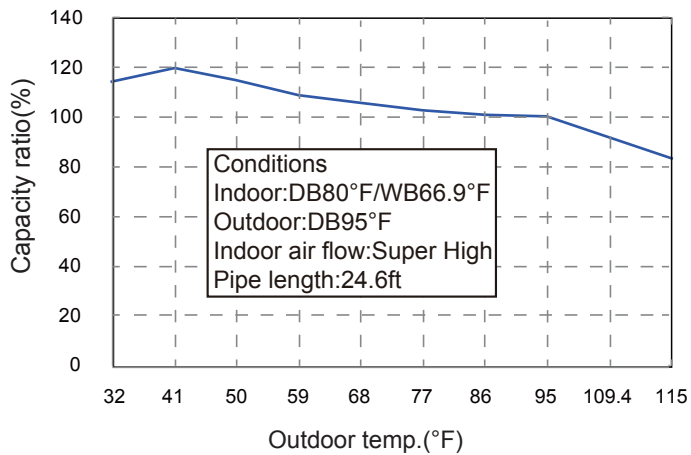

Heating

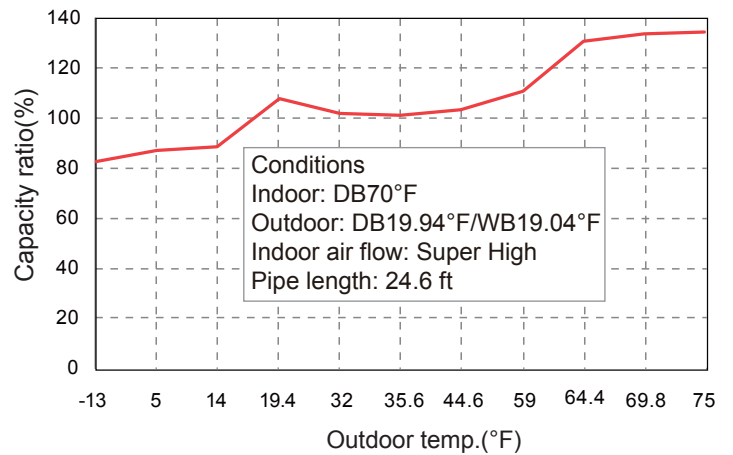

2. Specifications

24K:

Cooling operation ambient temperature range is 0°F~122°F.

Heating operation ambient temperature range is 19.4°F~75°F.

Cooling

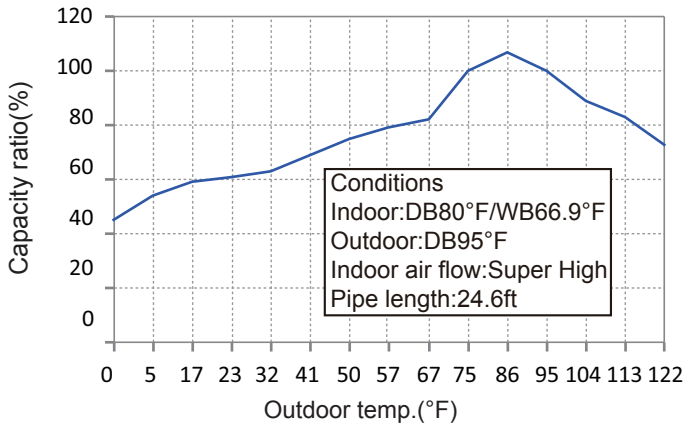

Heating

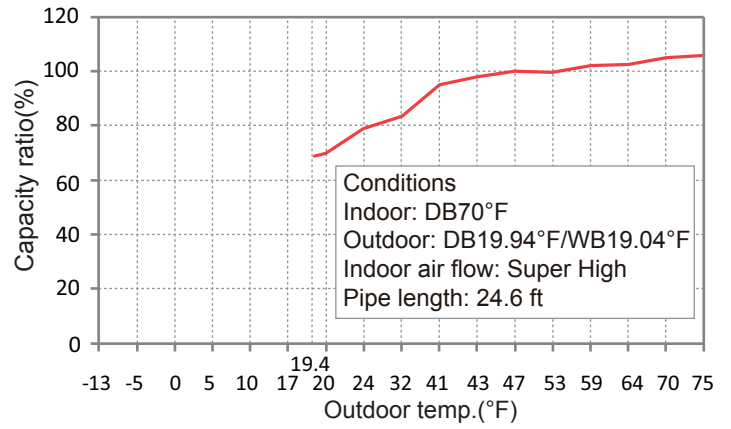

Cooling operation ambient temperature range is -20°F~122°F.

Heating operation ambient temperature range is -22°F~86°F.

Cooling

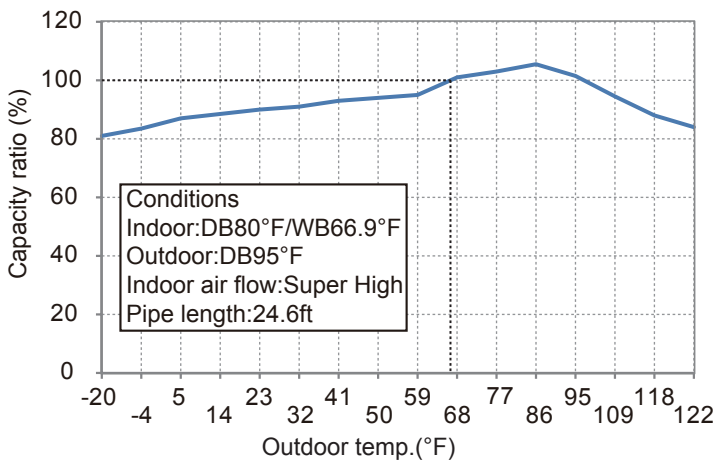

Heating

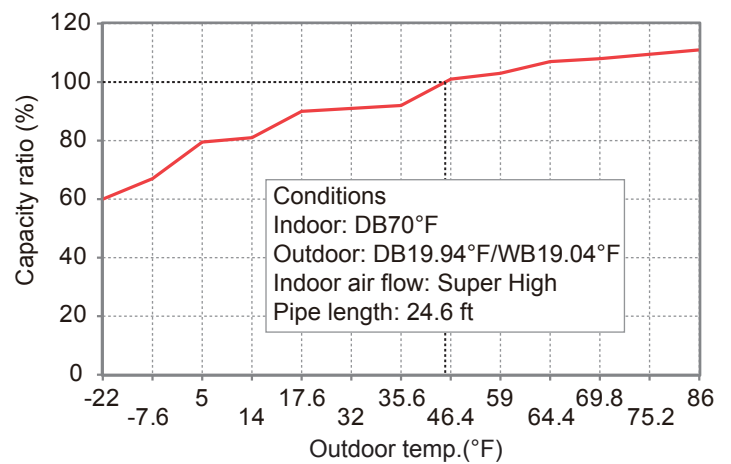

2. Specifications

2.3 Cooling and Heating Data Sheet in Rated Frequency

Cooling:

Rated cooling condition(°F) (DB/WB)		Model	Pressure of gas pipe connecting indoor and outdoor unit	Inlet and outlet pipe temperature of heat exchanger		Fan speed of indoor unit	Fan speed of outdoor unit
Indoor	Outdoor		PSIG	T1 (°F)	T2 (°F)		
80/66.9	95/-	09K	130~142	in:46.4~51.8 out:51.8~57.2	in:167~181.4 out:98.6~118.4	Super High	High
80/66.9	95/-	12K	130~142	in:46.4~51.8 out:51.8~57.2	in:167~181.4 out:98.6~118.4	Super High	High
80/66.9	95/-	18K	130~142	in:46.4~51.8 out:51.8~57.2	in:167~181.4 out:98.6~118.4	Super High	High
80/66.9	95/-	24K	130~142	in:46.4~51.8 out:51.8~57.2	in:167~181.4 out:98.6~118.4	Super High	High

Heating:

Rated heating condition(°F) (DB/WB)		Model	Pressure of gas pipe connecting indoor and outdoor unit	Inlet and outlet pipe temperature of heat exchanger		Fan speed of indoor unit	Fan speed of outdoor unit
Indoor	Outdoor		PSIG	T1 (°F)	T2 (°F)		
70/60	19.94/19.04	09K	362~406	in:167~181.4 out:98.6~113	in:33.8~37.4 out:35.6~42.8	Super High	High
70/60	19.94/19.04	12K	362~406	in:167~181.4 out:98.6~113	in:33.8~37.4 out:35.6~42.8	Super High	High
70/60	19.94/19.04	18K	507~550	in:167~181.4 out:98.6~113	in:33.8~37.4 out:35.6~42.8	Super High	High
70/60	19.94/19.04	24K	507~550	in:167~181.4 out:98.6~113	in:33.8~37.4 out:35.6~42.8	Super High	High

Instruction:

T1: Inlet and outlet pipe temperature of evaporator

T2: Inlet and outlet pipe temperature of condenser

P: Pressure at the side of big valve

Connection pipe length: 16.4/24.6 ft.

3. Outline Dimension Diagram

3.1 Indoor Unit

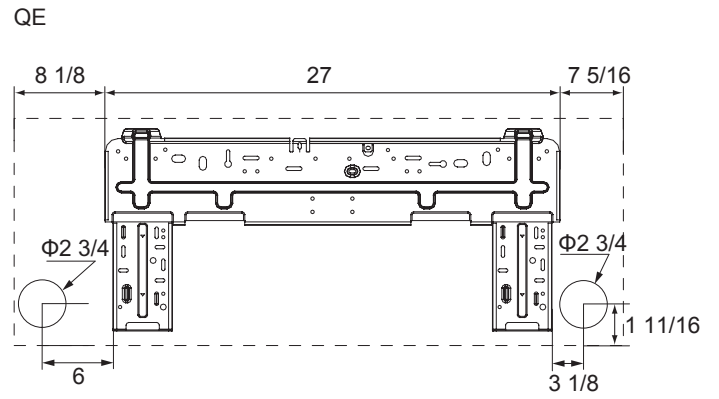
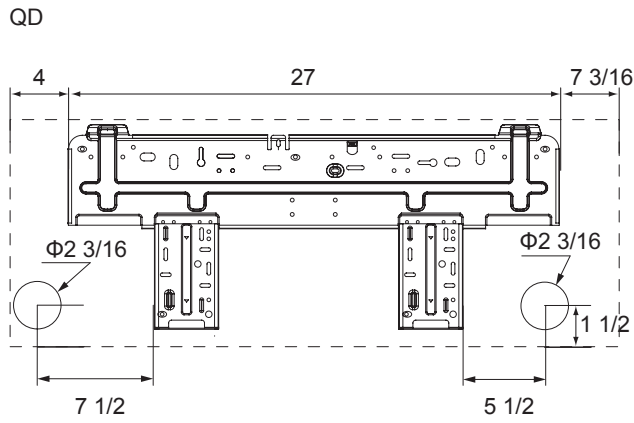
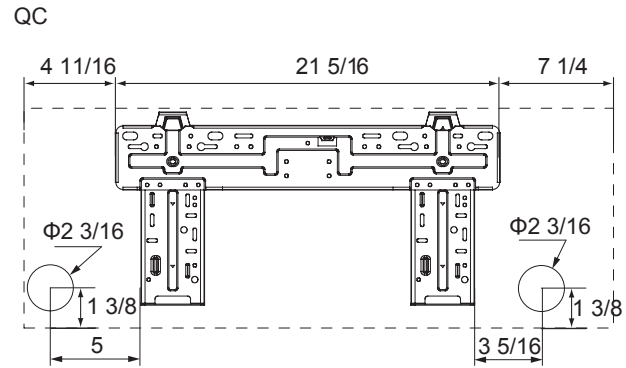
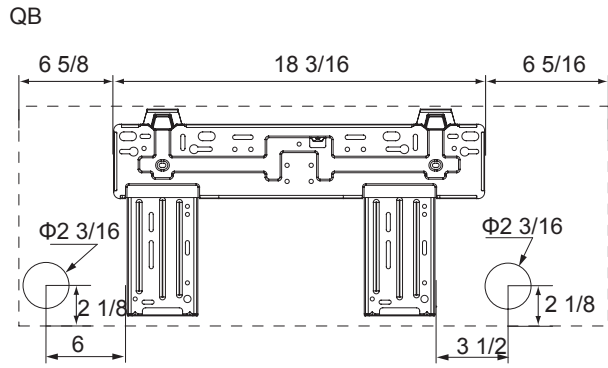
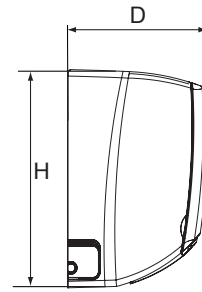
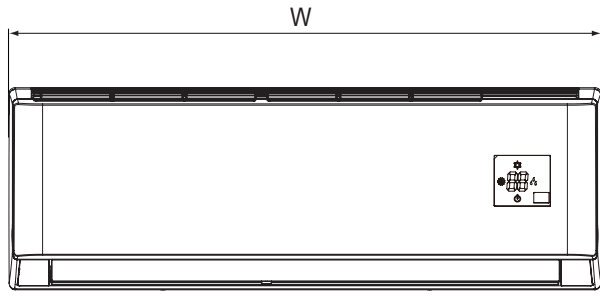

Unit:inch

Model	W	H	D
QB	31 7/64	10 53/64	7 7/8
QC	33 17/64	11 3/8	8 15/64
QD	38 3/16	11 13/16	8 55/64
QE	42 28/64	12 51/64	9 44/64

3. Outline Dimension Diagram

3.2 Outdoor Unit

GRHFRT12ASA GRHFRT12AS

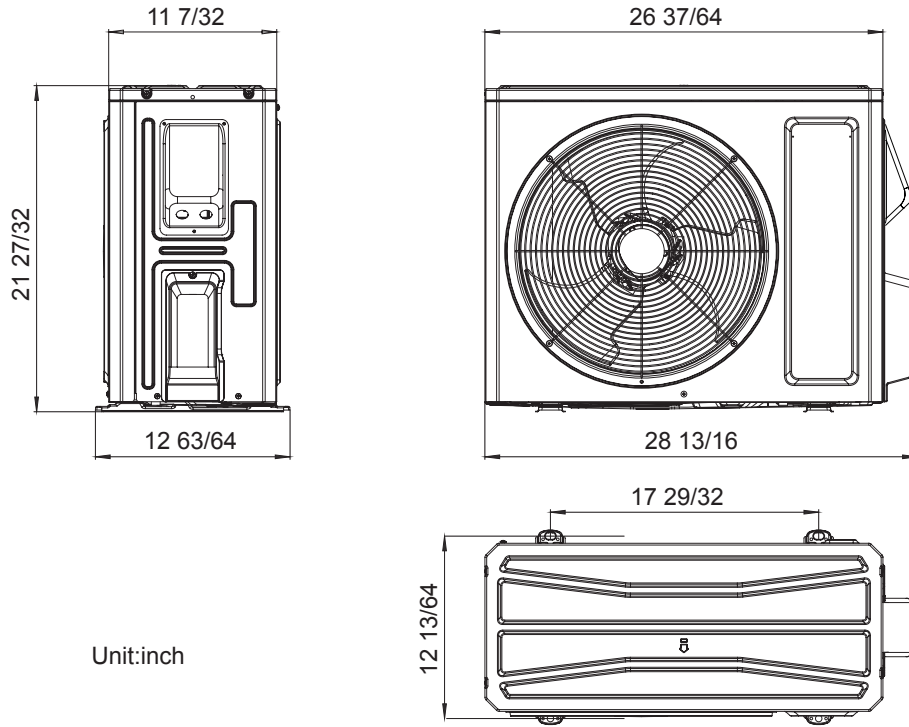

GRHFRT18AS

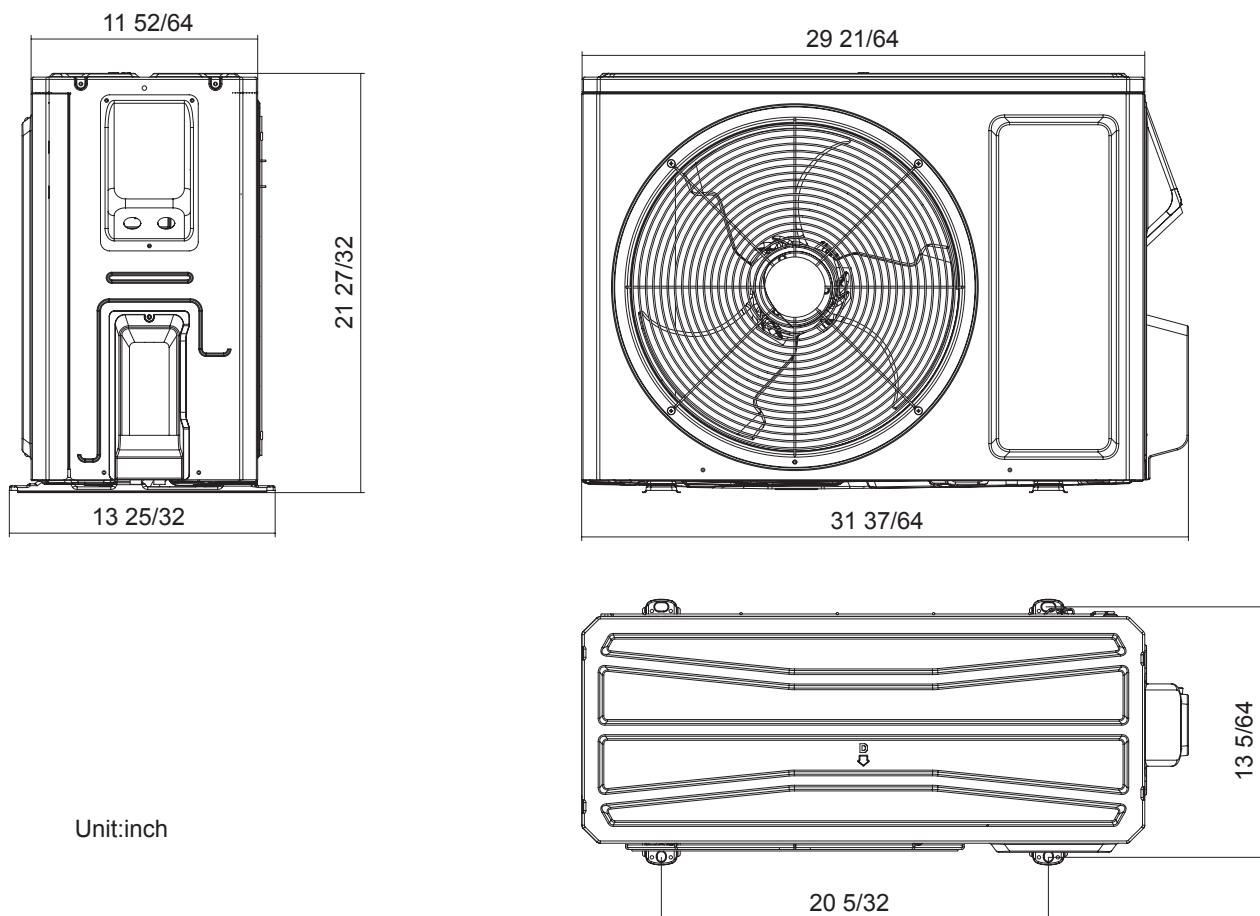

4. Refrigerant System Diagram

GRHFRT12ASA
GWHFRT18S

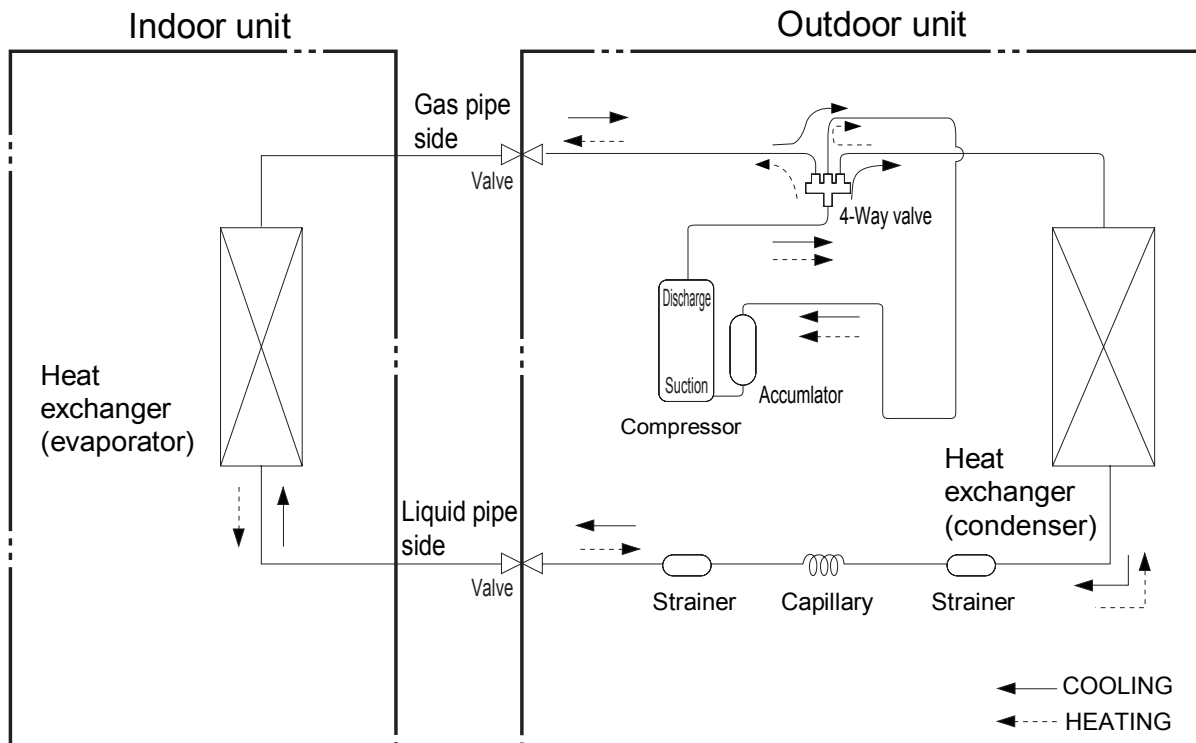

Connection pipe specification
 Liquid pipe: 1/4"
 Gas pipe: 3/8" (09/12K)
 Gas pipe: 1/2" (18K)
 Gas pipe: 5/8" (24K)

5. Electrical Part

GWHFRT18S / GRHFRT18AS

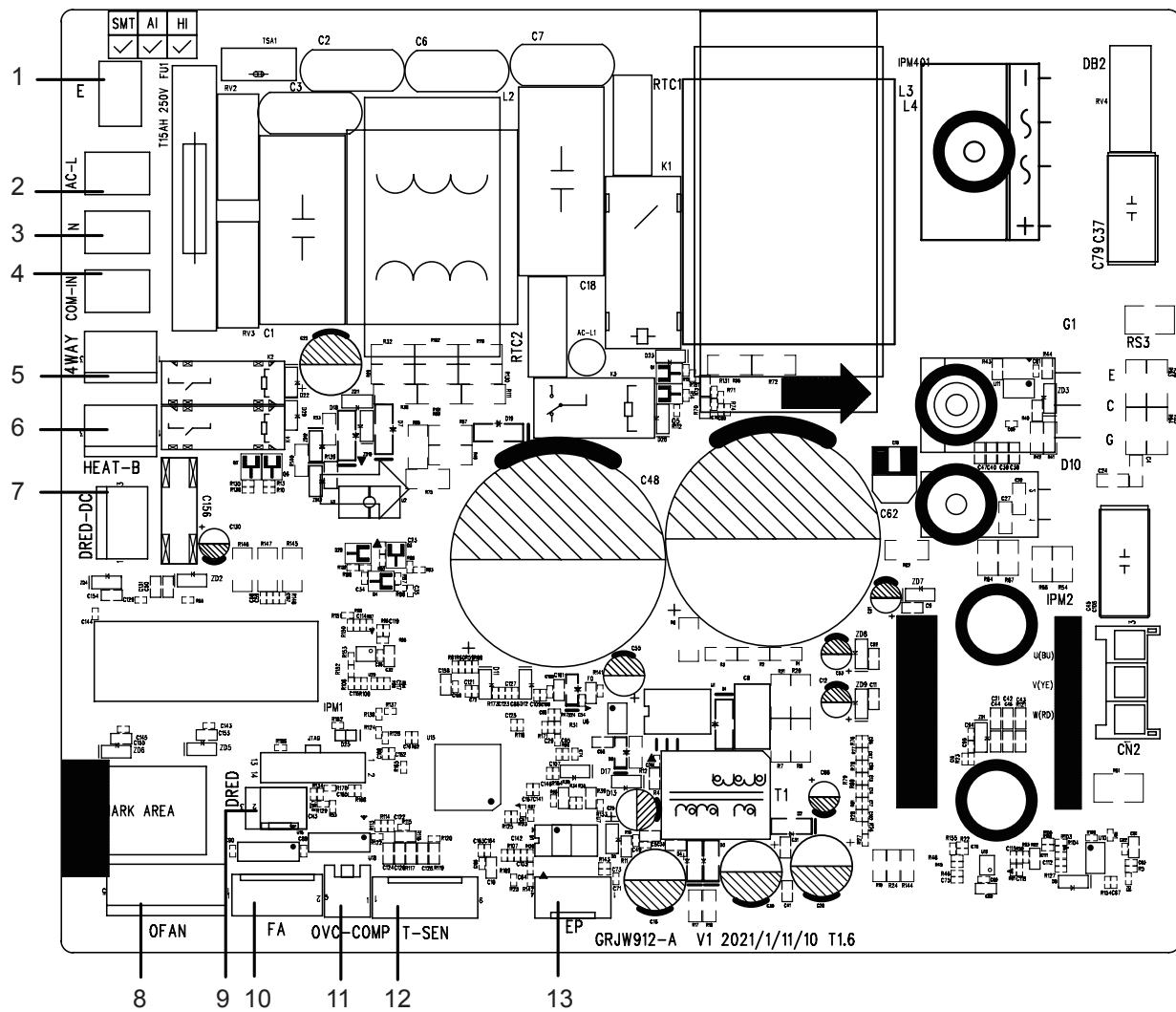

No.	Name	No.	Name
1	Earthing wire	8	Outdoor fan
2	Live wire	9	DRED(Reserved)
3	Neutral wire	10	Electronic expansion valve
4	Communication wire	11	Compressor Overload
5	4-way valve	12	Temperature sensor
6	Electric heating of chassis	13	Compressor
7	DRED-DC(Reserved)		

5. Electrical Part

GWH18QDXE-D3DNB2A/O GWC18QDXE-D3DNB2A/O

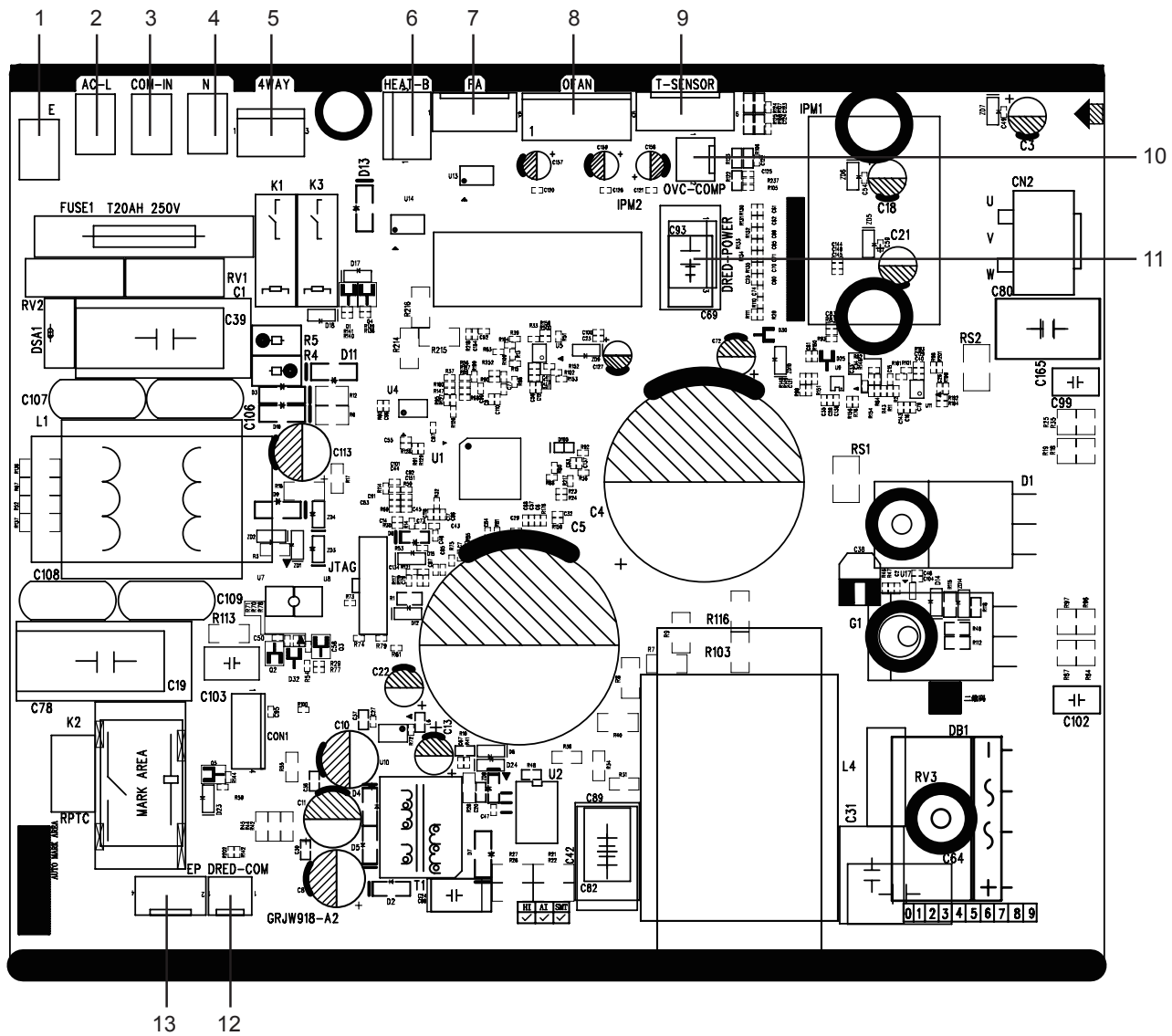

No.	Name	No.	Name
1	Earthing wire	8	Fan terminal
2	Live wire	9	Temperature sensor
3	Communication wire	10	Overload of compressor
4	Neutral wire	11	Dred power supply
5	4-way valve	12	Dred communication
6	Electric heating of chassis	13	E disk
7	Electronic expansion valve		

5. Electrical Part

GWHFRT24S / GRHFRT24AS

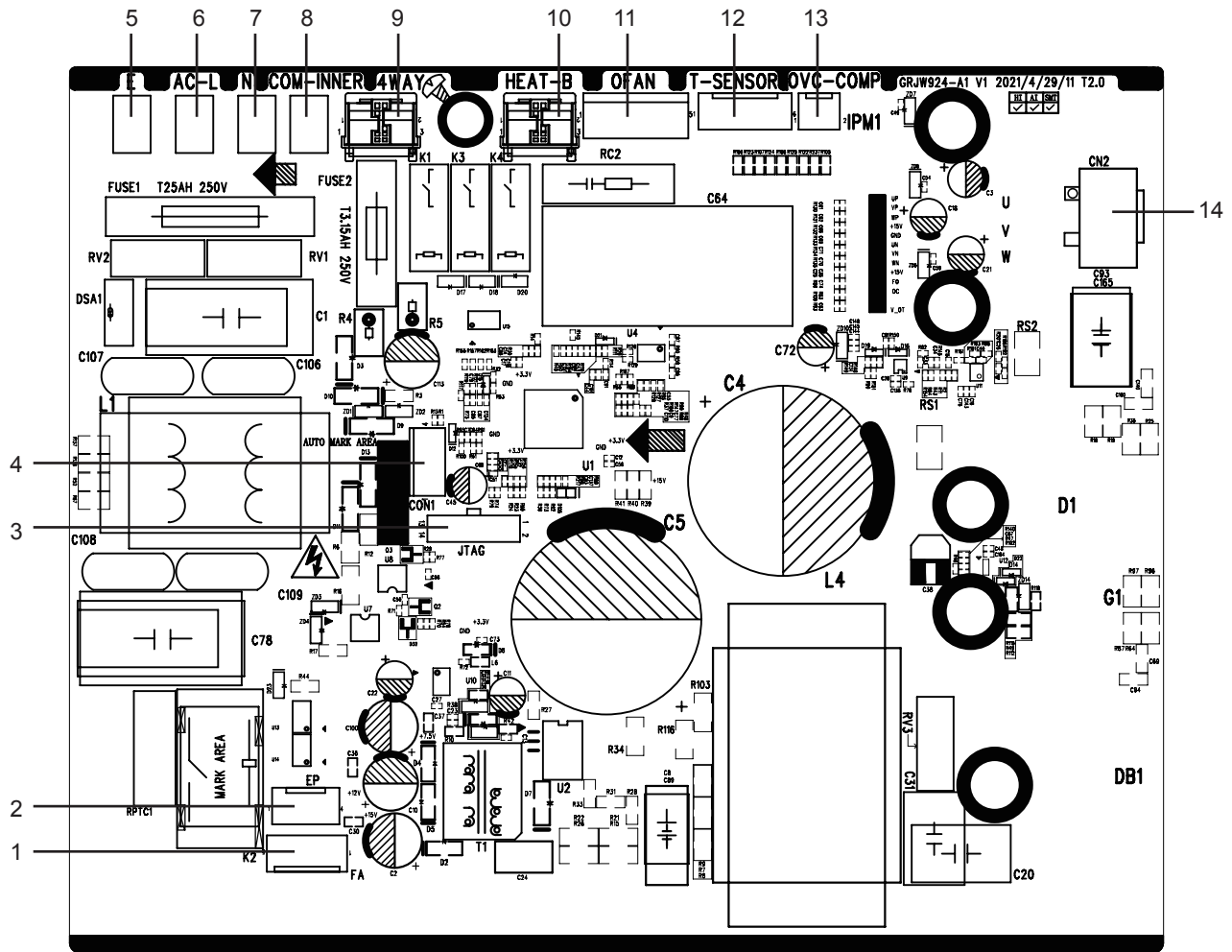

No.	Name	No.	Name
1	Electronic expansion valve	8	Communication wire
2	E disk	9	4-way valve
3	Program debug interface	10	Electric heating of chassis
4	Interface monitoring	11	AC fan
5	Earthing wire	12	Temperature sensor
6	Live wire	13	Overload of compressor
7	Neutral wire	14	Compressor terminal

5. Electrical Part

GRHFRT12ASA
GWHFRT12SA

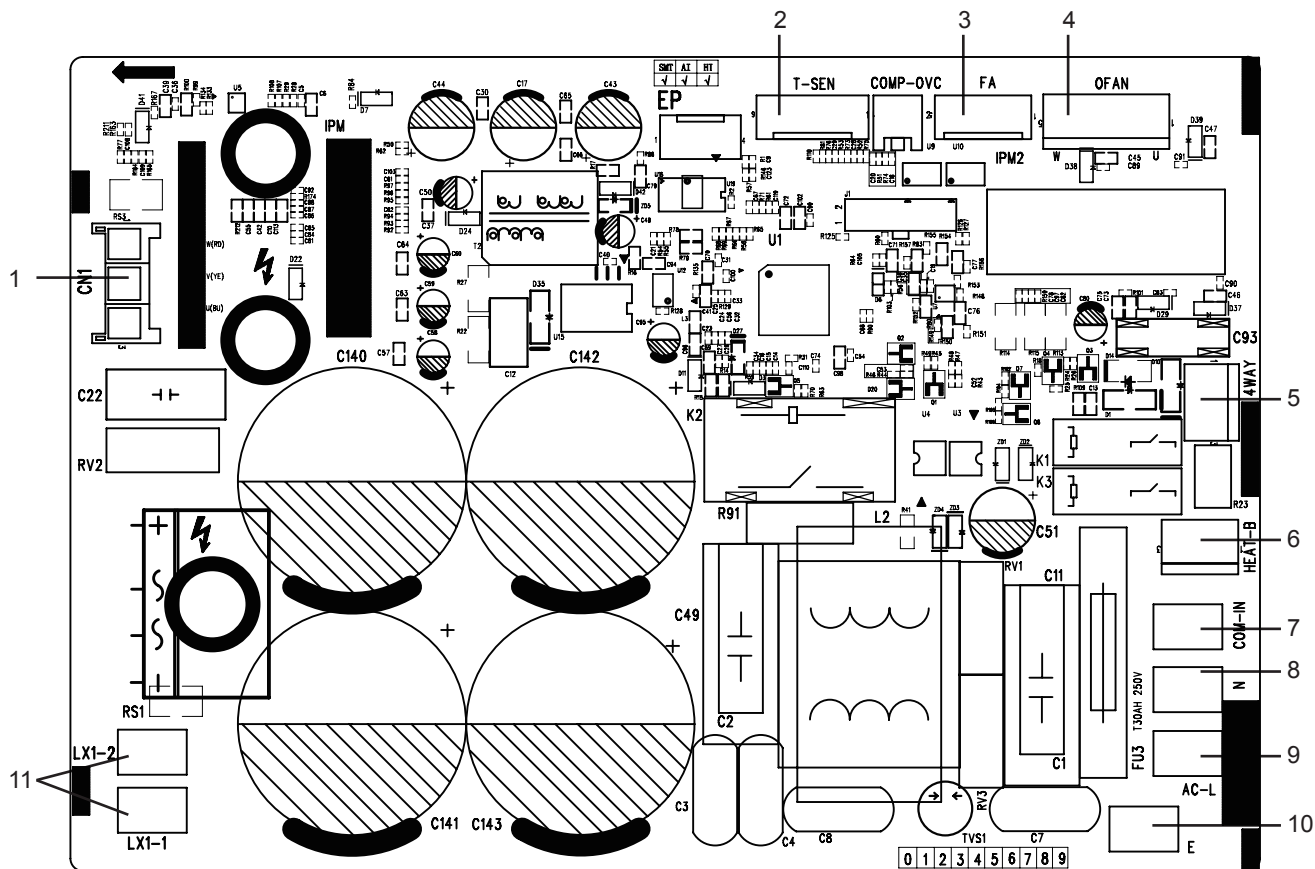

No.	Name
1	Three-phase terminal of compressor
2	Temperature sensor
3	Electronic expansion valve
4	Outdoor fan
5	4-way valve
6	Electric heating of chassis

No.	Name
7	Terminal of communication wire
8	Neutral wire
9	Live wire
10	Earthing wire
11	Interface of reactor

5. Electrical Part

GWH24AGEXH-D3DNA1A/O GWC24AGEXH-D3DNA1A/O

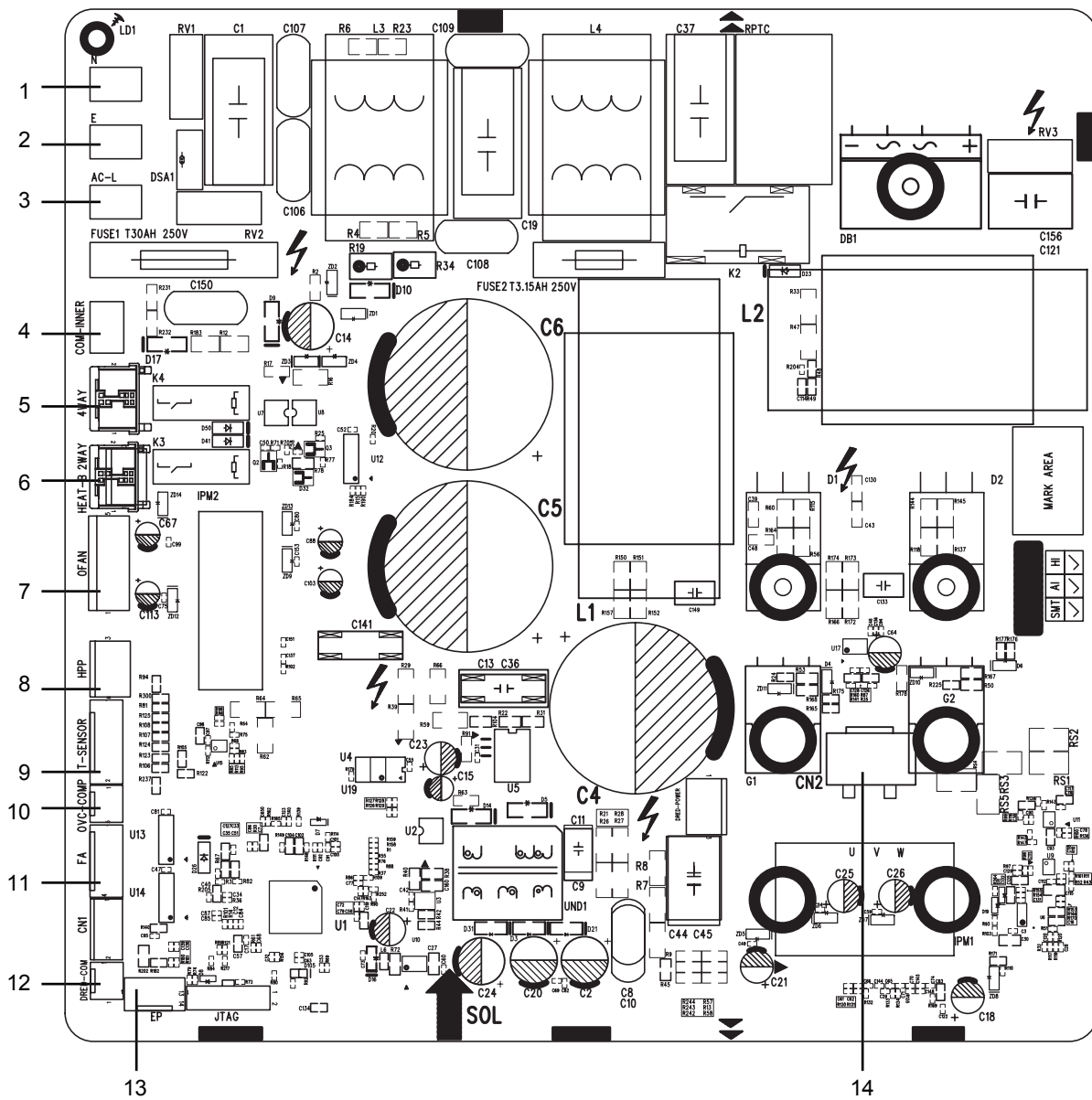

No.	Name
1	Neutral wire
2	Grounding wire
3	Live wire
4	Communication wire
5	4-way valve
6	Electric heating belt of chassis
7	Outdoor fan

No.	Name
8	Terminal of high pressure protection
9	Temperature sensor
10	Overload interface of compressor
11	Terminal of electronic expansion valve
12	Terminal of DRED
13	E disk(Reserved)
14	Terminal of compressor wire

6. Function and Control

6.1 Remote Controller Introduction

Buttons on remote controller for YAN1F6F(WiFi)



Introduction for buttons on remote controller

NOTE:

- This is a general use remote controller, it could be used for the air conditioners with multifunction; For some function, which the model doesn't have, if press the corresponding button on the remote controller that the unit will keep the original running status.
- After putting through the power, the air conditioner will give out a sound. Power indicator "U" is ON. After that, you can operate the air conditioner by using remote controller.
- Under on status, pressing the button on the remote controller, the signal icon "U" on the display of remote controller will blink once and the air conditioner will give out a "di" sound, which means the signal has been sent to the air conditioner.
- Under off status, set temperature and clock icon will be displayed on the display of remote controller (If timer on, timer off and light functions are set, the corresponding icons will be displayed on the display of remote controller at the same time); Under on status, the display will show the corresponding set function icons.

button

Press this button to turn on the unit. Press this button again to turn off the unit.

button

Press this button to select your required operation mode.

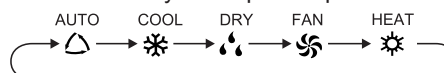

- When selecting auto mode, air conditioner will operate automatically according to ex-factory setting. Under auto mode, temperature can be displayed. Under auto mode, set temperature can be adjusted. Press "FAN" button can adjust fan speed. Press "SWING" button can adjust fan blowing angle.
- After selecting cool mode, air conditioner will operate under cool mode. Cool indicator on indoor unit is ON (This indicator is not available for some models). Press "▲" or "▼" button to adjust set temperature. Press "FAN" button to adjust fan speed. Press "SWING" button to adjust fan blowing angle.
- When selecting dry mode, the air conditioner operates at low speed under dry mode. Dry indicator on indoor unit is ON (This indicator is not available for some models). Under dry mode, fan speed can't be adjusted. Press "SWING" button to adjust fan blowing angle.
- When selecting fan mode, the air conditioner will only blow fan, no cooling and no heating. Press "FAN" button to adjust fan speed. Press "SWING" button to adjust fan blowing angle.
- When selecting heat mode, the air conditioner operates under heat mode. Heat indicator on indoor unit is ON (This indicator is not available for some models). Press "▲" or "▼" button to adjust set temperature. Press "FAN" button to adjust fan speed. Press "SWING" button to adjust fan blowing angle.

Introduction for icons on display screen

	I feel	
	Set fan speed	
	Turbo mode	
	Send signal	
Operation mode		Auto mode
		Cool mode
		Dry mode
		Fan mode
		Heat mode
	Sleep mode	
	8°C heating function	
	Health mode	
	Scavenging function	
	X-FAN function	
Temp. display type		Set temp.
		Indoor ambient temp.
		Outdoor ambient temp.
	Clock	
	Set temperature	
	WiFi function	
	Set time	
	TIMER ON / TIMER OFF	
	Light	
	Up & down swing	
	Child lock	

6. Function and Control

NOTE:

- For preventing cold air, after starting up heat mode, indoor unit will delay 1~5 minutes to blow air (Actual delay time depends on indoor ambient temperature).
- Set temperature range from remote controller: 16~30°C (61~86°F); Fan speed: auto, low speed, medium speed, high speed.
- This mode indicator is not available for some models.
- Cooling only unit won't receive heat mode signal. If setting heat mode with remote controller, press "U" button can't start up the unit.

FAN button

Press this button can set fan speed circularly as: auto (AUTO), low (▲), medium (▲▲), high (▲▲▲).

NOTE:

- Under AUTO speed, air conditioner will select proper fan speed automatically according to factory default setting.
- Fan speed under dry mode is low speed.
- X-FAN function: Hold fan speed button for 2s in COOL or DRY mode, the icon "⊕" is displayed and the indoor fan will continue operation for a few minutes in order to dry the indoor unit even though you have turned off the unit. After energization, X-FAN OFF is defaulted. X-FAN is not available in AUTO, FAN or HEAT mode. This function indicates that moisture on evaporator of indoor unit will be blown after the unit is stopped to avoid mould.
- Having set X-FAN function on: After turning off the unit by pressing "U" button, indoor fan will continue running for a few minutes at low speed. In this period, hold fan speed button for 2s to stop indoor fan directly.
- Having set X-FAN function off: After turning off the unit by pressing "U" button, the complete unit will be off directly.

SWING button

Press this button can select up & down swing angle. Fan blow angle can be selected circularly as below:

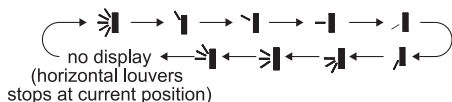

- When selecting "➤", air conditioner is blowing fan automatically. Horizontal louver will automatically swing up & down at maximum angle.
- When selecting "↖, ↗, ↘, ↙", air conditioner is blowing fan at fixed position. Horizontal louver will stop at the fixed position.
- When selecting "↗, ↘, ↙", air conditioner is blowing fan at fixed angle. Horizontal louver will send air at the fixed angle.
- Hold "➤" button above 2s to set your required swing angle. When reaching your required angle, release the button.

NOTE:

- "↗, ↘, ↙" may not be available. When air conditioner receives this signal, the air conditioner will blow fan automatically.

TURBO button

Under cool or heat mode, press this button to turn to quick cool or quick heat mode. "⊕" icon is displayed on remote controller.

Press this button again to exit turbo function and "⊕" icon will disappear.

▲ / ▼ button

Press "▲" or "▼" button once increase or decrease set temperature 1°C(°F). Holding "▲" or "▼" button, 2s later, set temperature on remote controller will change quickly. On releasing button after setting is finished, temperature indicator on indoor unit will change accordingly. (Temperature can't be adjusted under auto mode)

When setting TIMER ON, TIMER OFF or CLOCK, press "▲" or "▼" button to adjust time. (Refer to CLOCK, TIMER ON, TIMER OFF buttons)

SLEEP button

Under cool or heat mode, press this button to start up sleep function.

"☾" icon is displayed on remote controller.

Press this button again to cancel sleep function and "☾" icon will disappear.

TEMP button

By pressing this button, you can see indoor set temperature, indoor ambient temperature or outdoor ambient temperature on indoor unit's display. The setting on remote controller is selected circularly as below:



- When selecting "🏠" or no display with remote controller, temperature indicator on indoor unit displays set temperature.
- When selecting "🏠🌡️" with remote controller, temperature indicator on indoor unit displays indoor ambient temperature.
- When selecting "🏠🌡️!" with remote controller, temperature indicator on indoor unit displays outdoor ambient temperature.

NOTE:

- Outdoor temperature display is not available for some models. At that time, indoor unit receives "🏠🌡️!" signal, while it displays indoor set temperature.
- It's defaulted to display set temperature when turning on the unit. There is no display in the remote controller.
- Only for the models whose indoor unit has dual-8 display.
- When selecting displaying of indoor or outdoor ambient temperature, indoor temperature indicator displays corresponding temperature and automatically turn to display set temperature after three or five seconds

WiFi button

Press "WiFi" button to turn on WiFi function, "WiFi" icon will be displayed on the remote controller.

Hold "WiFi" button for 5s to turn off WiFi function and "WiFi" icon will disappear.

Under off status, press "MODE" and "WiFi" buttons simultaneously for 1s, WiFi module will restore factory settings.

NOTE:

- This function is only available for some models.

6. Function and Control

button

Press this button to turn off display light on indoor unit. "☀" icon on remote controller disappears.

Press this button again to turn on display light. "☀" icon is displayed.

button

Press this button to set clock time. "🕒" icon on remote controller will blink. Press "▲" or "▼" button within 5s to set clock time. Each pressing of "▲" or "▼" button, clock time will increase or decrease 1 minute. If hold "▲" or "▼" button, 2s later, time will change quickly. Release this button when reaching your required time. Press "CLOCK" button to confirm the time. "🕒" icon stops blinking.

NOTE:

- Clock time adopts 24-hour mode.
- The interval between two operations can't exceeds 5s. Otherwise, remote controller will quit setting status. Operation for TIMER ON/TIMER OFF is the same.

button

- TIMER ON button

"TIMER ON" button can set the time for timer on. After pressing this button, "🕒" icon disappears and the word "ON" on remote controller blinks. Press "▲" or "▼" button to adjust TIMER ON setting. After each pressing "▲" or "▼" button. TIMER ON setting will increase or decrease 1min. Holding "▲" or "▼" button, 2s later, the time will change quickly until reaching your required time. Press "TIMER ON" to confirm it. The word "ON" will stop blinking. "🕒" icon resumes displaying. Cancel TIMER ON: Under the condition that TIMER ON is started up, press "TIMER ON" button to cancel it.

- TIMER OFF button

"TIMER OFF" button can set the time for timer off. After pressing this button, "🕒" icon disappears and the word "OFF" on remote controller blinks. Press "▲" or "▼" button to adjust TIMER OFF setting. After each pressing "▲" or "▼" button, TIMER OFF setting will increase or decrease 1min. Holding "▲" or "▼" button, 2s later, the time will change quickly until reaching your required time.

Press "TIMER OFF" and the word "OFF" will stop blinking. "🕒" icon resumes displaying.

Cancel TIMER OFF. Under the condition that TIMER OFF is started up, press "TIMER OFF" button to cancel it.

NOTE:

- Under on and off status, you can set TIMER OFF or TIMER ON simultaneously.
- Before setting TIMER ON or TIMER OFF, please adjust the clock time.
- After starting up TIMER ON or TIMER OFF, set the constant circulating valid. After that, air conditioner will be turned on or turned off according to setting time. "⏻" button has no effect on setting. If you don't need this function, please use remote controller to cancel it.

Function introduction for combination buttons

Energy-saving function

Under cooling mode, press "TEMP" and "CLOCK" buttons simultaneously to start up or turn off energy-saving function. When energy-saving function is started up, "SE" will be shown on remote controller, and air conditioner will adjust the set temperature automatically according to ex-factory setting to reach to the best energy-saving effect.

Press "TEMP" and "CLOCK" buttons simultaneously again to exit energy-saving function.

NOTE:

- Under energy-saving function, fan speed is defaulted at auto speed and it can't be adjusted.
- Under energy-saving function, set temperature can't be adjusted. Press "TURBO" button and the remote controller won't send signal.
- Sleep function and energy-saving function can't operate at the same time. If energy-saving function has been set under cool mode, press sleep button will cancel energy-saving function. If sleep function has been set under cool mode, start up the energy-saving function will cancel sleep function.

8°C heating function

Under heat mode, press "TEMP" and "CLOCK" buttons simultaneously to start up or turn off 8°C heating function. When this function is started up, "🌡" and "8°C" will be shown on remote controller, and the air conditioner keep the heating status at 8°C. Press "TEMP" and "CLOCK" buttons simultaneously again to exit 8°C heating function.

NOTE:

- Under 8°C heating function, fan speed is defaulted at auto speed and it can't be adjusted.
- Under 8°C heating function, set temperature can't be adjusted. Press "TURBO" button and the remote controller won't send signal.
- Sleep function and 8°C heating function can't operate at the same time. If 8°C heating function has been set under heat mode, press "SLEEP" button will cancel 8°C heating function. If sleep function has been set under heat mode, start up the 8°C heating function will cancel sleep function.
- Under °F temperature display, the remote controller will display 46°F heating.

Child lock function

Press "▲" or "▼" simultaneously to turn on or turn off child lock function. When child lock function is on, "🔒" icon is displayed on remote controller. If you operate the remote controller, the "🔒" icon will blink three times without sending signal to the unit.

Temperature display switchover function

Under OFF status, press "▼" and "MODE" buttons

6. Function and Control

simultaneously to switch temperature display between °C and °F.

I FEEL function

Press "▲" and "MODE" buttons simultaneously to start I FEEL function and "🌡️" will be displayed on the remote controller. After this function is set, the remote controller will send the detected ambient temperature to the controller and the unit will automatically adjust the indoor temperature according to the detected temperature. Press this two buttons simultaneously again to close I FEEL function and "🌡️" will disappear.

Please put the remote controller near user when this function is set. Do not put the remote controller near the object of high temperature or low temperature in order to avoid detecting inaccurate ambient temperature.

When I FEEL function is turned on, the remote controller should be put within the area where indoor unit can receive the signal sent by the remote controller.

Replacement of batteries in remote controller

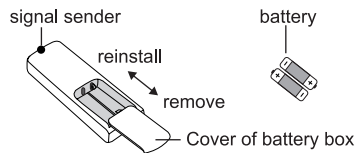

1. Press the back side of remote controller marked with "🔓" OPEN, as shown in the fig, and then push out the cover of battery box along the arrow direction.
2. Replace two 7# (AAA 1.5V) dry batteries, and make sure the position of "+" polar and "-" polar are correct.
3. Reinstall the cover of battery box.

NOTICE :

- During operation, point the remote control signal sender at the receiving window on indoor unit.
- The distance between signal sender and receiving window should be no more than 8m, and there should be no obstacles between them.
- Signal may be interfered easily in the room where there is fluorescent lamp or wireless telephone; remote controller should be close to indoor unit during operation.
- Replace new batteries of the same model when replacement is required.
- When you don't use remote controller for a long time, please take out the batteries.
- If the display on remote controller is fuzzy or there's no display, please replace batteries.

6. Function and Control

Buttons on remote controller for YAY1FF

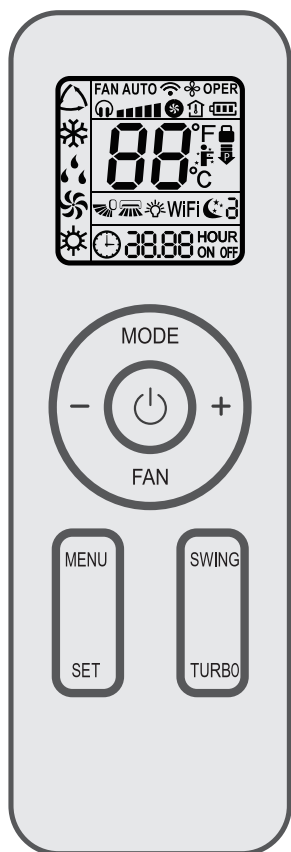

Introduction for icons on display screen

	I feel	
	Set fan speed	
	Turbo mode	
	Send signal	
Operation mode		Auto mode
		Cool mode
		Dry mode
		Fan mode
		Heat mode
	Sleep mode	
	Light	
	Power limiting operation	
	X-FAN function	
	Indoor ambient temp.	
	Clock	
	Set temperature	
	WiFi function	
	Set time	
	TIMER ON / TIMER OFF	
	Left & right swing	
	Up & down swing	
	Child lock	
	Quiet	

NOTE:

• This is a general use remote controller. It could be used for the air conditioner with multifunction. For the functions which the model doesn't have, if press the corresponding button on the remote controller, the unit will keep the original running status.

• After putting through the power, the air conditioner will give out a sound. Power indicator "⏻" is ON. After that, you can operate the air conditioner by using remote controller.

• Under on status, pressing the button on the remote controller, the signal icon "📶" on the display of remote controller will blink once and the air conditioner will give out a "di" sound, which means the signal has been sent to the air conditioner.

⏻ button

Press this button to turn on the unit. Press this button again to turn off the unit.

MODE button

Press this button to select your required operation mode:

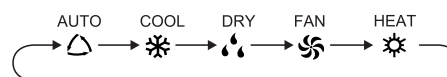

• When selecting auto mode, air conditioner will operate automatically according to ambient temperature. Set temperature can't be adjusted and will not be displayed as well. Press "FAN" button can adjust fan speed. Press "SWING" button can adjust fan blowing angle.

• When selecting cool mode, air conditioner will operate under cool mode. Press "+" or "-" button to adjust set temperature. Press "FAN" button to adjust fan speed. Press "SWING" button to adjust fan blowing angle.

• When selecting dry mode, the air conditioner operates at low speed under dry mode. Under dry mode, fan speed can't be adjusted. Press "SWING" button to adjust fan blowing angle.

• When selecting fan mode, the air conditioner will only blow fan, no cooling and no heating. Press "FAN" button to adjust fan speed. Press "SWING" button to adjust fan blowing angle.

• When selecting heat mode, the air conditioner operates under heat mode. Press "+" or "-" button to adjust set temperature. Press "FAN" button to adjust fan speed. Press "SWING" button to adjust fan blowing angle.

NOTE:

• For preventing cold air, after starting up heat mode, indoor unit will delay 1~5 minutes to blow air (Actual delay time depends on indoor ambient temperature).

• Set temperature range from remote controller: 16~30°C (61~86°C).

• This mode indicator is not available for some models.

• Cooling only unit won't receive heat mode signal. If setting heat mode with remote controller, press "⏻" button can't start up the unit.

FAN button

This button is used for setting Fan Speed in the sequence that goes from AUTO, , , , , to then back to Auto.

NOTE:

• Under AUTO speed, air conditioner will select proper fan speed automatically according to factory default setting.

• It's low fan speed under dry mode.

• X-FAN function: Holding fan speed button for 2s in cool or dry

6. Function and Control

mode, the icon "❄️" is displayed and the indoor fan will continue operation for a few minutes in order to dry the indoor unit even though you have turned off the unit. After energization, X-FAN OFF is defaulted. X-FAN is not available in auto, fan or heat mode.

This function indicates that moisture on evaporator of indoor unit will be blown after the unit is stopped to avoid mould.

- Having set X-FAN function on: After turning off the unit by pressing "⏻" button, indoor fan will continue running for a few minutes at low speed. In this period, hold fan speed button for 2s to stop indoor fan directly.

Having set X-FAN function off: After turning off the unit by pressing "⏻" button, the complete unit will be off directly.

- If equipped with the product of 4 kinds of fan speed, when setting "🌀", "🌀", the unit will work in low speed; when setting "🌀", "🌀🌀", the unit will work in medium speed; when setting "🌀🌀", "🌀🌀🌀", the unit will work in high speed.

- / + button

Press "+" or "-" button once increase or decrease set temperature 1°C(°F). Holding "+" or "-" button, 2s later, set temperature on remote controller will change quickly. On releasing button after setting is finished, temperature indicator on indoor unit will change accordingly. (Temperature can't be adjusted under auto mode) When setting TIMER ON, TIMER OFF or CLOCK, press "+" or "-" button to adjust time. (Refer to CLOCK, TIMER ON, TIMER OFF functions).

MENU button

Press this button to select submenu function and then press "SET" button to set the function status of submenu. The submenu can be selected circularly as follows:

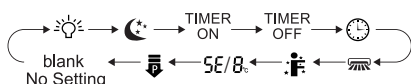

NOTE:

- Some menu's function may be unavailable under different models.

Light function

When selecting light function, light icon "💡" flashes for 5s; press "SET" button within 5s to turn off display light on indoor unit and "💡" icon on remote controller disappears. Press "SET" button again within 5s to turn on display light and "💡" icon is displayed.

Sleep function

When selecting sleeping function, sleeping icon "🌙" flashes for 5s; press "SET" button within 5s can select Sleep 1 (🌙1), Sleep 2 (🌙2), Sleep 3 (🌙3) and cancel Sleep circularly.

- Sleep 1 is Sleep mode 1, in Cool modes; sleep status after run for one hour, the main unit setting temperature will increase 1°C, two hours, setting temperature increased 2°C, then the unit will run at this setting temperature; In Heat mode: sleep status after

run for one hour, the setting temperature will decrease 1°C, two hours, setting temperature will decrease 2°C, then the unit will run at this setting temperature.

- Sleep 2 is sleep mode 2, that is air conditioner will run according to the presetting a group of sleep temperature curve.

- Sleep 3-the sleep curve setting under Sleep mode by DIY;

(1) Under Sleep 3 mode, press "Turbo" button for a long time, remote controller enters into user individuation sleep setting status, at this time, the time of remote controller will display "1hour", the setting temperature "88" will display the corresponding temperature of last setting sleep curve and blink (The first entering will display according to the initial curve setting value of original factory);

(2) Adjust "+" and "-" button, could change the corresponding setting temperature, after adjusted, press "Turbo" button for confirmation

(3) At this time, 1hour will be automatically increased at the timer position on the remote control, (that are "2hours" or "3hours" or "8hours"), the place of setting temperature "88" will display the corresponding temperature of last setting sleep curve and blink;

(4) Repeat the above step (2)~(3) operation, until 8 hours temperature setting finished, sleep curve setting finished, at this time, the remote controller will resume the original timer display; temperature display will resume to original setting temperature.

- Sleep 3- the sleep curve setting under Sleep mode by DIY could be inquired:

The user could accord to sleep curve setting method to inquire the presetting sleep curve, enter into user individuation sleep setting status, but do not change the temperature, press "Turbo" button directly for confirmation. Note: In the above presetting or enquiry procedure, if continuously within 10s, there is no button pressed, the sleep curve setting within 10s, there is no button pressed, the sleep curve setting status will be automatically quit and resume to display the original displaying. In the presetting or enquiry procedure, press "⏻" button, "MODE" button, the sleep curve setting or enquiry status will quit similarly.

NOTE:

- If equipped with the product with one kind of sleeping mode only, set Sleep 1 (🌙1) or Sleep 3 (🌙3) to activate sleeping function.

TIMER ON function

TIMER ON function can set the time for timer on. Under TIMER ON function status, "🕒" icon disappears and the word "ON" on remote controller blinks. Press "+" or "-" button to adjust TIMER ON setting. After each pressing "+" or "-" button TIMER ON setting will increase or decrease 1min. Hold "+" or "-" button, 2s later, the time will change quickly until reaching your required time. Press "SET" button to confirm it within 5S. The word "ON" will stop blinking.

Cancel TIMER ON: Press "MENU" button to TIMER ON function and the characters "ON" flashes on the remote controller; press

6. Function and Control

"SET" button until the characters "ON" disappears.

TIMER OFF function

TIMER OFF function can set the time for timer off. Under TIMER OFF function status, "⊕" icon disappears and the word "OFF" on remote controller blinks. Press "+" or "-" button to adjust TIMER OFF setting. After each pressing "+" or "-" button TIMER OFF setting will increase or decrease 1min.

Hold "+" or "-" button, 2s later, the time will change quickly until reaching your required time, press "SET" button to confirm it within 5S. The word "OFF" will stop blinking.

Cancel TIMER OFF: Press "MENU" button to TIMER OFF function and the characters "OFF" flashes on the remote controller; press "SET" button until the characters "OFF" disappears.

CLOCK function

CLOCK function can set clock time. Under CLOCK function status, "⊕" icon on remote controller will blink. Press "+" or "-" button within 5s to set clock time. Each pressing of "+" or "-" button, clock time will increase or decrease 1 min. If hold "+" or "-" button, 2s later, time will change quickly.

Release this button when reaching your required time, press "SET" button to confirm it within 5S. The "⊕" icon will stop blinking.

Left & right swing function

When selecting left & right swing function, left & right swing icon "↔" flashes for 5s; press "SET" button within 5s to select left & right swing angle.

Fan blow angle can be selected circularly as below:

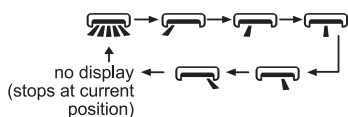

NOTE:

- The function is only available for some models.

SE Energy-saving function

Under cooling mode, when selecting energy-saving function, energy-saving function icon "SE" flashes for 5s; press "SET" button within 5s to turn on or turn off energy-saving function. When energy-saving function is started up, "SE" will be shown on remote controller, and air conditioner will adjust the set temperature automatically according to ex-factory setting to reach to the best energy-saving effect. Press "SET" button again to exit energy-saving function.

8°C-heating function

Under heating mode, when selecting 8°C-heating function, 8°C-heating icon "8°C" flashes for 5s; press "SET" button within 5s to

turn on or turn off 8°C-heating. When 8°C-heating is started up, "8°C" will be shown on remote controller, and the air conditioner keep the heating status at 8°C. Press "SET" button again to exit 8°C-heating function.

NOTE:

Under °F temperature display, the remote controller will display 46°F heating.

Power limiting function

Power limiting function is for limiting the power of the whole unit. When selecting power limiting function, power limiting icon "P" flashes for 5s; press "SET" button within 5s and the remote controller will circularly display as follows:

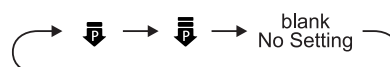

- Maximum power limited under the "P" mode is lower than that of "P" mode.
- If the current power is lower than the maximum power of "P" mode, then the power will not be limited after entering into such mode.
- For the model with one outdoor unit and two indoor units, if any one of indoor units enters into power limiting function, the outdoor unit will enter into the set limiting power mode of indoor unit; when two indoor units enter into power limiting mode, then the power of outdoor unit will be limited according to the lower power of the two indoor units.

NOTE:

- The function is only available for some models.

SWING button

Press this button can select up & down swing angle. Fan blow angle can be selected circularly as below:

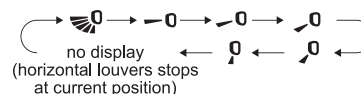

- When selecting "↕", air conditioner is blowing fan automatically. Horizontal louver will automatically swing up & down at maximum angle.
- When selecting "↔", air conditioner is blowing fan at fixed position. Horizontal louver will stop at the fixed position.
- Hold "↕" button above 2s to set your required swing angle. When reaching your required angle, release the button.

NOTE:

- Press this button continuously for more than 2s, the main unit will swing back and forth from up to down, and then loosen the button, the unit present position of guide louver will be kept immediately.
- Under up and down swing mode, when the status is switched from off to "↕", if press this button again 2s later, "↕" status will switch to off status directly; if press this button again within 2s,

6. Function and Control

the change of swing status will also depend on the circulation sequence stated above.

TURBO button

Under COOL or HEAT mode, press this button to turn to quick COOL or quick HEAT mode. "⊞" icon is displayed on remote controller. Press this button again to exit turbo function and "⊞" icon will disappear. If start this function, the unit will run at super-high fan speed to cool or heat quickly so that the ambient temperature approaches the preset temperature as soon as possible.

Function introduction for combination buttons

Child lock function

Press "+" and "-" simultaneously to turn on or turn off child lock function. When child lock function is on, "🔒" icon is displayed on remote controller. If you operate the remote controller, the "🔒" icon will blink three times without sending signal to the unit.

Temperature display switchover function

Under OFF status, press "-" and "MODE" buttons simultaneously to switch temperature display between °C and °F.

Auto clean function

Under unit off status, hold "MODE" and "FAN" buttons simultaneously for 5s to turn on or turn off the auto clean function. When the auto clean function is turned on, indoor unit displays "CL". During the auto clean process of evaporator, the unit will perform fast cooling or fast heating. There may be some noise, which is the sound of flowing liquid or thermal expansion or cold shrinkage. The air conditioner may blow cool or warm air, which is a normal phenomenon. During cleaning process, please make sure the room is well ventilated to avoid affecting the comfort.

NOTE:

- The auto clean function can only work under normal ambient temperature. If the room is dusty, clean it once a month; if not, clean it once every three months. After the auto clean function is turned on, you can leave the room. When auto clean is finished, the air conditioner will enter standby status.
- This function is only available for some models.

WiFi function

Press "MODE" and "TURBO" button simultaneously to turn on or turn off WiFi function. When WiFi function is turned on, the "WiFi" icon will be displayed on remote controller; Long press "MODE" and "TURBO" buttons simultaneously for 10s, remote controller will send WiFi reset code and then the WiFi function will be turned

on. WiFi function is defaulted ON after energization of the remote controller.

NOTE:

- This function is only available for some models.

Ambient temperature display function

UPress "SWING" and "SET" buttons simultaneously, you can see indoor ambient temperature on indoor unit's display and the "🌡️" icon will be displayed on remote controller. The setting on remote controller is selected circularly as below:

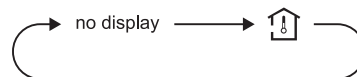

Adjustable temperature under auto mode

The remote controller defaulted that the set temperature can't be adjusted and it won't be displayed under AUTO mode; when pressing "+" and "SET" buttons simultaneously under off status for consecutive 5s, the set temperature can be adjusted under AUTO mode. After setting is succeeded, the set temperature on the remote controller flashes for 3 times

Night mode

Under cooling or heating mode, when turning on sleep mode and turn to low speed or quiet notch, the outdoor unit would enter into night mode.

NOTE:

- When you feel that the cooling and heating effect is poor, please press "FAN" button to other fan speed or press "SLEEP" button to exit the night mode.
- The night mode can only work under normal ambient temperature.
- This function is only available for some models.

Replacement of batteries in remote controller

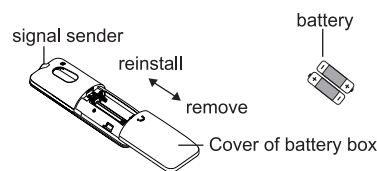

1. Press the back side of remote controller marked with "🔑", as shown in the fig, and then push out the cover of battery box along the arrow direction.
2. Replace two 7# (AAA 1.5V) dry batteries, and make sure the position of "+" polar and "-" polar are correct.
3. Reinstall the cover of battery box.

NOTE:

- During operation, point the remote control signal sender at the receiving window on indoor unit.

6. Function and Control

- The distance between signal sender and receiving window should be no more than 8m, and there should be no obstacles between them.
- Signal may be interfered easily in the room where there is fluorescent lamp or wireless telephone; remote controller should be close to indoor unit during operation.
- Replace new batteries of the same model when replacement is required.
- When you don't use remote controller for a long time, please take out the batteries.
- If the display on remote controller is fuzzy or there's no display, please replace batteries.

6. Function and Control

Buttons on remote controller for YAP1F7F(WiFi)



Introduction for icons on display screen

	I feel
	Set fan speed
	Turbo mode
	Send signal
	Auto mode
	Cool mode
	Dry mode
	Fan mode
	Heat mode
	Sleep mode
	8°C heating function
	Power limiting operation
	Health mode
	Scavenging function
	X-FAN function
	Set temp.
	Indoor ambient temp.
	Outdoor ambient temp.
	Clock
	Set temperature
	WiFi function
	Set time
	TIMER ON / TIMER OFF
	Left & right swing
	Up & down swing
	Child lock
	Quiet

NOTE:

- This is a general use remote controller. It could be used for the air conditioner with multifunction. For the functions which the model doesn't have, if press the corresponding button on the remote controller, the unit will keep the original running status.
- After putting through the power, the air conditioner will give out a sound. Power indicator "⏻" is ON. After that, you can operate the air conditioner by using remote controller.
- Under on status, pressing the button on the remote controller, the signal icon "📶" on the display of remote controller will blink once and the air conditioner will give out a "di" sound, which means the signal has been sent to the air conditioner.
- As for the models with functions of WiFi or wired controller, the indoor unit must have been controlled by standard remote controller under auto mode first, and then the function of adjustable temperature under auto mode can be realized by APP or the wired controller.

- This remote controller can adjust the temperature under auto mode. When matching with the unit which is without the function of adjustable temperature under auto mode, the set temperature under auto mode may be invalid, or the displayed set temperature on the unit is not same as that on the remote controller under auto mode.

1. ON/OFF button

Press this button to turn on the unit. Press this button again to turn off the unit.

2. MODE button

Press this button to select your required operation mode.



- When selecting auto mode, air conditioner will operate automatically according to ex-factory setting. Press "FAN" button can adjust fan speed. Press "🌀" / "🌀" button can adjust fan

6. Function and Control

blowing angle.

- After selecting cool mode, air conditioner will operate under cool mode. Press "△" or "▽" button to adjust set temperature. Press "FAN" button to adjust fan speed. Press "扇" / "↻" button to adjust fan blowing angle.

- When selecting dry mode, the air conditioner operates at low speed under dry mode. Under dry mode, fan speed can't be adjusted. Press "扇" / "↻" button to adjust fan blowing angle.

- When selecting fan mode, the air conditioner will only blow fan, no cooling and no heating. All indicators are OFF. Press "FAN" button to adjust fan speed. Press "扇" / "↻" button to adjust fan blowing angle.

- When selecting heating mode, the air conditioner operates under heat mode. Press "△" or "▽" button to adjust set temperature. Press "FAN" button to adjust fan speed. Press "扇" / "↻" button to adjust fan blowing angle. (Cooling only unit won't receive heating mode signal. If setting heat mode with remote controller, press ON/OFF button can't start up the unit).







NOTE:

- For preventing cold air, after starting up heating mode, indoor unit will delay 1~5 minutes to blow air (actual delay time is depend on indoor ambient temperature).

- Set temperature range from remote controller: 16~30°C (61~86°F);

- Under auto mode, temperature can be displayed; Under auto mode, set temperature can be adjusted. This mode indicator is not available for some models.

3. FAN button

This button is used for setting Fan Speed in the sequence that goes from AUTO, , , , , , to , then back to Auto.

NOTE:

- Under AUTO speed, air conditioner will select proper fan speed automatically according to factory default setting.

It's low fan speed under dry mode.

- X-FAN function: Holding fan speed button for 2s in cool or dry mode, the icon "☼" is displayed and the indoor fan will continue operation for a few minutes in order to dry the indoor unit even though you have turned off the unit. After energization, X-FAN OFF is defaulted. X-FAN is not available in auto, fan or heat mode.

- This function indicates that moisture on evaporator of indoor unit will be blowed after the unit is stopped to avoid mould.

- Having set X-FAN function on: After turning off the unit by pressing ON/OFF button, indoor fan will continue running for a few minutes at low speed. In this period, hold fan speed button for 2s to stop indoor fan directly.

Having set X-FAN function off: After turning off the unit by pressing ON/OFF button, the complete unit will be off directly.

4. TURBO button

Under COOL or HEAT mode, press this button to turn to quick COOL or quick HEAT mode. "⊙" icon is displayed on remote controller. Press this button again to exit turbo function and "⊙" icon will disappear. If start this function, the unit will run at super-high fan speed to cool or heat quickly so that the ambient temperature approaches the preset temperature as soon as possible.

5. △ / ▽ button

- Press "△" or "▽" button once increase or decrease set temperature 1°C (°F). Holding "△" or "▽" button, 2s later, set temperature on remote controller will change quickly. On releasing button after setting is finished, temperature indicator on indoor unit will change accordingly.

- When setting T-ON, T-OFF or CLOCK, press "△" or "▽" button to adjust time. (Refer to CLOCK, T-ON, T-OFF buttons)

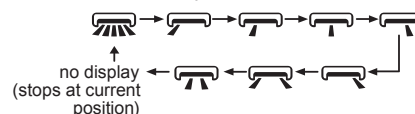

6. 扇 button

Press this button can select left & right swing angle. Fan blow angle can be selected circularly as below:



NOTE:

- Press this button continuously more than 2s, the main unit will swing back and forth from left to right, and then loosen the button, the unit will stop swinging and present position of guide louver will be kept immediately.

- Under left and right swing mode, when the status is switched from off to , if press this button again 2s later,  status will switch to off status directly; if press this button again within 2s, the change of swing status will also depend on the circulation sequence stated above.

- The function is only available for some models.

7. ↻ button

Press this button can select up & down swing angle. Fan blow angle can be selected circularly as below:

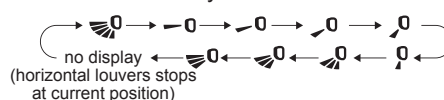

- When selecting "☼", air conditioner is blowing fan automatically. Horizontal louver will automatically swing up & down at maximum angle.

- When selecting "↔", "↔", "↔", "↔", "↔", air conditioner is blowing fan at fixed position. Horizontal louver will stop at the fixed position.





- When selecting "↔", "↔", "↔", air conditioner is blowing fan at

6. Function and Control

fixed angle









- Hold "  " button above 2s to set your required swing angle. When reaching your required angle, release the button.

NOTE:









- "  ,  ,  " may not be available. When air conditioner receives this signal, the air conditioner will blow fan automatically.
- Press this button continuously more than 2s, the main unit will swing back and forth from up to down, and then loosen the button, the unit will stop swinging and present position of guide louver will be kept immediately.
- Under swing up and down mode, when the status is switched from off to  , if press this button again 2s later,  status will switch to off status directly; if press this button again within 2s, the change of swing status will also depend on the circulation sequence stated above.

8. T-ON / T-OFF button

- T-ON button

"T-ON" button can set the time for timer on. After pressing this button, "  " icon disappears and the word "ON" on remote controller blinks. Press "  " or "  " button to adjust T-ON setting. After each pressing "  " or "  " button, T-ON setting will increase or decrease 1min. Hold "  " or "  " button, 2s later, the time will change quickly until reaching your required time. Press "T-ON" to confirm it. The word "ON" will stop blinking."  " icon resumes displaying. Cancel T-ON: Under the condition that T-ON is started up, press "T-ON" button to cancel it.



- T-OFF button

"T-OFF" button can set the time for timer off. After pressing this button, "  " icon disappears and the word "OFF" on remote controller blinks. Press "  " or "  " button to adjust T-OFF setting. After each pressing "  " or "  " button, T-OFF setting will increase or decrease 1min. Hold "  " or "  " button, 2s later, the time will change quickly until reaching your required time. Press "T-OFF" word "OFF" will stop blinking. "  " icon resumes displaying. Cancel T-OFF: Under the condition that T-OFF is started up, press "T-OFF" button to cancel it.

NOTE:









- Under on and off status, you can set T-OFF or T-ON simultaneously.
- Before setting T-ON or T-OFF, please adjust the clock time.
- After starting up T-ON or T-OFF, set the constant circulating valid.
- After that, air conditioner will be turned on or turned off according to setting time. ON/OFF button has no effect on setting. If you don't need this function, please use remote controller to cancel it.

9. I FEEL button

Press this button to start I FEEL function and "  " will be displayed on the remote controller. After this function is set, the remote controller will send the detected ambient temperature to the controller and the unit will automatically adjust the indoor temperature according to the detected temperature. Press this button again to cancel I FEEL function and "  " will disappear.

- Please put the remote controller near user when this function is set. Do not put the remote controller near the object of high temperature or low temperature in order to avoid detecting inaccurate ambient temperature. When I FEEL function is turned on, the remote controller should be put within the area where indoor unit can receive the signal sent by the remote controller.



10. CLOCK button

Press this button to set clock time. "  " icon on remote controller will blink. Press "  " or "  " button within 5s to set clock time. Each pressing of "  " or "  " button, clock time will increase or decrease 1 minute. If hold "  " or "  " button, 2s later, time will change quickly. Release this button when reaching your required time. Press "CLOCK" button to confirm the time. "  " icon stops blinking.

NOTE:

- Clock time adopts 24-hour mode.
- The interval between two operations can't exceed 5s. Otherwise, remote controller will quit setting status. Operation for T-ON/T-OFF is the same.

11. SLEEP button

- Press this button, can select Sleep 1 ( 1), Sleep 2 ( 2), Sleep 3 ( 3) and cancel the Sleep, circulate between these, after electrified, Sleep Cancel is defaulted
- Sleep 1 is Sleep mode 1, in Cool modes; sleep status after run for one hour, the main unit setting temperature will increase 1 , two hours, setting temperature increased 2°C, then the unit will run at this setting temperature; In Heat mode: sleep status after run for one hour, the setting temperature will decrease 1 , two hours, setting temperature will decrease 2 , then the unit will run at this setting temperature.
- Sleep 2 is sleep mode 2, that is air conditioner will run according to the presetting a group of sleep temperature curve.
- Sleep 3-the sleep curve setting under Sleep mode by DIY;
(1) Under Sleep 3 mode, press "Turbo" button for a long time, remote controller enters into user individuation sleep setting status, at this time, the time of remote controller will display "1hour", the setting temperature "88" will display the corresponding temperature of last setting sleep curve and blink (The first entering will display according to the initial curve setting value of original factory);
(2) Adjust "+" and "-" button, could change the corresponding setting temperature, after adjusted, press "Turbo" button for confirmation

6. Function and Control

(3) At this time, 1hour will be automatically increased at the timer position on the remote control, (that are "2hours" or "3hours" or "8hours"), the place of setting temperature "88" will display the corresponding temperature of last setting sleep curve and blink;

(4) Repeat the above step (2)~(3) operation, until 8 hours temperature setting finished, sleep,curve setting finished, at this time, the remote controller will resume the original timer display; temperature display will resume to original setting temperature.

- Sleep3- the sleep curve setting under Sleep mode by DIY could be inquired:

The user could accord to sleep curve setting method to inquire the presetting sleep curve, enter into user individuation sleep setting status, but do not change the temperature, press "Turbo" button directly for confirmation. Note: In the above presetting or enquiry procedure, if continuously within 10s, there is no button pressed, the sleep curve setting within 10s, there is no button pressed, the sleep curve setting status will be automatically quit and resume to display the original displaying. In the presetting or enquiry procedure, press "ON/OFF" button, "Mode" button, "Sleep" button, the sleep curve setting or enquiry status will quit similarly.

12. WiFi button





Press " WiFi " button to turn on WiFi function, "WiFi " icon will be displayed on the remote controller; Hold " WiFi " button for 5s to turn off WiFi function and " WiFi " icon will disappear.

Under off status, press "MODE" and " WiFi " buttons simultaneously for 1s, WiFi module will restore factory settings.

NOTE:

- This function is only available for some models.

13. button

Press this button to achieve the on and off of health and scavenging functions in operation station. Press this button for the first time to start scavenging function; LCD displays "". Press the button for the second time to start health and scavenging functions simultaneously; LCD displays "" and "". Press this button for the third time to quit health and scavenging functions simultaneously. Press the button for the fourth time to start health function; LCD display "". Press this button again to repeat the operation above.

NOTE:

- This function is applicable to partial of models.

14. LIGHT button

Press this button to turn on or turn off the display light on the indoor unit.

The display light is defaulted on after energization.

15. TEMP button

Press this button, you can see indoor set temperature, indoor

ambient temperature on indoor unit's display. The setting on remote controller is selected circularly as below:



Function introduction for combination buttons

1. Energy-saving function

Under cooling mode, press "TEMP" and "CLOCK" buttons simultaneously to start up or turn off energysaving function. When energy-saving function is started up, "SE" will be shown on remote controller, and air conditioner will adjust the set temperature automatically according to ex-factorysetting to reach to the best energy-saving effect. Press "TEMP" and "CLOCK" buttons simultaneously again to exit energy-saving function.

NOTE:

- Under energy-saving function, fan speed is defaulted at auto speed and it can't be adjusted.
- Under energy-saving function, set temperature can't be adjusted. Press "TURBO" button and the remote controller won't send signal.
- Sleep function and energy-saving function can't operate at the same time. If energy-saving function has been set under cool mode, press sleep button will cancel energy-saving function. If sleep function has been set under cool mode, start up the energy-saving function will cancel sleep function.

2. 8°C heating function



Under heat mode, press "TEMP" and "CLOCK" buttons simultaneously to start up or turn off 8°C heating function. When this function is started up, " " and "8°C" will be shown on remote controller, and the air conditioner keep the heating status at 8°C.

Press "TEMP" and "CLOCK" buttons simultaneously again to exit 8°C heating function.

NOTE:

- Under 8°C heating function, fan speed is defaulted at auto speed and it can't be adjusted.
- Under 8°C heating function, set temperature can't be adjusted. Press "TURBO" button and the remote controller won't send signal.
- Sleep function and 8°C heating function can't operate at the same time. If 8°C heating function has been set under heat mode, press sleep button will cancel 8°C heating function. If sleep function has been set under heat mode, start up the 8°C heating function will cancel sleep function.
- Under °F temperature display, the remote controller will display 46°F heating.

3. Child lock function

Press "" and "" simultaneously to turn on or turn off child lock

6. Function and Control

function. When child lock function is on, "🔒" icon is displayed on remote controller. If you operate the remote controller, the "🔒" icon will blink three times without sending signal to the unit.

4. Temperature display switchover function

Under OFF status, press "▽" and "MODE" buttons simultaneously to switch temperature display between °C and °F.

5. Auto clean function

Under unit off status, hold "MODE" and "FAN" buttons simultaneously for 5s to turn on or turn off the auto clean function. When the auto clean function is turned on, indoor unit displays "CL". During the auto clean process of evaporator, the unit will perform fast cooling or fast heating. There may be some noise, which is the sound of flowing liquid or thermal expansion or cold shrinkage. The air conditioner may blow cool or warm air, which is a normal phenomenon. During cleaning process, please make sure the room is well ventilated to avoid affecting the comfort.

NOTE:

- The auto clean function can only work under normal ambient temperature. If the room is dusty, clean it once a month; if not, clean it once every three months. After the auto clean function is turned on, you can leave the room. When auto clean is finished, the air conditioner will enter standby status.
- This function is only available for some models.

6. 📶 function

Press "MODE" and "SLEEP" buttons simultaneously to start 📶 function.

📶 function is for limiting power of the whole unit. Press this button, the remote controller will circularly display as the following:



- Maximum power limited under the 📶 mode is lower than that of 📶 mode.
- If you want to cancel the power limiting function, press the button 📶 till the icon in remote controller is not displayed.
- When the remote controller is turned off, power limiting function is cancelled. If you want to activate the function, please repress this button.

- If the current power is lower than the maximum power of 📶 mode, then the power will not be limited after entering into such mode.
- For the model with one outdoor unit and two indoor units, if any one of indoor units enters into power limiting function, the outdoor unit will enter into the set limiting power mode of indoor unit; when two indoor units enter into power limiting mode, then the power of outdoor unit will be limited according to the lower power of the two indoor units.

NOTE:

- This function is only available for some models.

Replacement of batteries in remote controller

1. Lift the cover along the direction of arrow (as shown in Fig 1 ①).
2. Take out the original batteries (as shown in Fig 1 ②).
3. Place two 7# (AAA 1.5V) dry batteries, and make sure the position of "+" polar and "-" polar is correct (as shown in Fig 2 ③).
4. Reinstall the cover (as shown in Fig 2 ④).

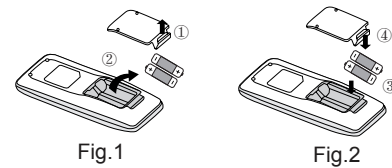

NOTICE:

- During operation, point the remote control signal sender at the receiving window on indoor unit.
- The distance between signal sender and receiving window should be no more than 8m, and there should be no obstacles between them.
- Signal may be interfered easily in the room where there is fluorescent lamp or wireless telephone; remote controller should be close to indoor unit during operation.
- Replace new batteries of the same model when replacement is required.
- When you don't use remote controller for a long time, please take out the batteries.
- If the display on remote controller is fuzzy or there's no display, please replace batteries.

6. Function and Control

Buttons on remote controller for YAN1F10F(WiFi)



Introduction for icons on display screen

	I feel	
	Set fan speed	
	Turbo mode	
	Send signal	
Operation mode		Auto mode
		Cool mode
		Dry mode
		Fan mode
		Heat mode
	Sleep mode	
	8°C heating function	
	Health mode	
	Scavenging function	
	X-FAN function	
Temp. display type		Set temp.
		Indoor ambient temp.
		Outdoor ambient temp.
	Clock	
	Set temperature	
	WiFi function	
	Set time	
	TIMER ON / TIMER OFF	
	Light	
	Up & down swing	
	Child lock	

Introduction for buttons on remote controller

NOTE:

- This is a general use remote controller, it could be used for the air conditioners with multifunction; For some function, which the model doesn't have, if press the corresponding button on the remote controller that the unit will keep the original running status.
- After putting through the power, the air conditioner will give out a sound. Power indicator "U" is ON. After that, you can operate the air conditioner by using remote controller.
- Under on status, pressing the button on the remote controller, the signal icon "📶" on the display of remote controller will blink once and the air conditioner will give out a "di" sound, which means the signal has been sent to the air conditioner.
- As for the models with functions of WiFi or wired controller, the indoor unit must has been controlled by standard remote controller under auto mode first, and then the function of adjustable temperature under auto mode can be realized by APP or the wired controller.
- This remote controller can adjust the temperature under auto mode. When matching with the unit which is without the function of adjustable temperature under auto mode, the set temperature under auto mode may be invalid, or the displayed set temperature on the unit is not same as that on the remote controller under auto mode.

button

Press this button to turn on the unit. Press this button again to turn off the unit.

button

Press this button to select your required operation mode.

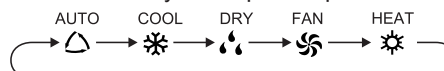

- When selecting auto mode, air conditioner will operate automatically according to ex-factory setting. Under auto mode, temperature can be displayed. Under auto mode, set temperature can be adjusted. Press "FAN" button can adjust fan speed. Press "SWING" button can adjust fan blowing angle.
- After selecting cool mode, air conditioner will operate under cool mode. Cool indicator on indoor unit is ON(This indicator is not available for some models). Press "▲" or "▼" button to adjust set temperature. Press "FAN" button to adjust fan speed. Press "SWING" button to adjust fan blowing angle.
- When selecting dry mode, the air conditioner operates at low speed under dry mode. Dry indicator on indoor unit is ON(This indicator is not available for some models). Under dry mode, fan speed can't be adjusted. Press "SWING" button to adjust fan blowing angle.
- When selecting fan mode, the air conditioner will only blow fan, no cooling and no heating. Press "FAN" button to adjust fan speed. Press "SWING" button to adjust fan blowing angle.
- When selecting heat mode, the air conditioner operates under heat mode. Heat indicator on indoor unit is ON (This indicator is not available for some models). Press "▲" or "▼" button to adjust

6. Function and Control

set temperature. Press "FAN" button to adjust fan speed. Press "SWING" button to adjust fan blowing angle. (Cooling only unit won't receive heat mode signal. If setting heat mode with remote controller, press ON/OFF button can't start up the unit)

NOTE:

- For preventing cold air, after starting up heat mode, indoor unit will delay 1~5 minutes to blow air (Actual delay time depends on indoor ambient temperature).
- Set temperature range from remote controller: 16~30°C (61~86°F); Fan speed: auto, low speed, medium speed, high speed.
- Under auto mode, temperature can be displayed;
Under auto mode, set temperature can be adjusted.

FAN button

Press this button can set fan speed circularly as: auto (AUTO), low (), medium (), high ().

NOTE:

- Under AUTO speed, air conditioner will select proper fan speed automatically according to factory default setting.
- Fan speed under dry mode is low speed.
- X-FAN function: Hold fan speed button for 2s in COOL or DRY mode, the icon "☼" is displayed and the indoor fan will continue operation for a few minutes in order to dry the indoor unit even though you have turned off the unit. After energization, X-FAN OFF is defaulted. X-FAN is not available in AUTO, FAN or HEAT mode. This function indicates that moisture on evaporator of indoor unit will be blown after the unit is stopped to avoid mould.
- Having set X-FAN function on: After turning off the unit by pressing "⏻" button, indoor fan will continue running for a few minutes at low speed. In this period, hold fan speed button for 2s to stop indoor fan directly.
- Having set X-FAN function off: After turning off the unit by pressing "⏻" button, the complete unit will be off directly.

SWING button

Press this button can select up & down swing angle. Fan blow angle can be selected circularly as below:

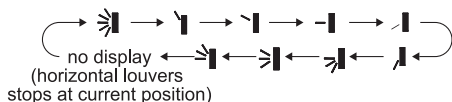

- When selecting "☼", air conditioner is blowing fan automatically. Horizontal louver will automatically swing up & down at maximum angle.
- When selecting "↕", air conditioner is blowing fan at fixed position. Horizontal louver will stop at the fixed position.
- When selecting "↗", air conditioner is blowing fan at fixed angle. Horizontal louver will send air at the fixed angle.
- Hold "☼" button above 2s to set your required swing angle. When reaching your required angle, release the button.

NOTE:

- "↗, ↘, ↙" may not be available. When air conditioner receives this signal, the air conditioner will blow fan automatically.

TURBO button

Under cool or heat mode, press this button to turn to quick cool or quick heat mode. "⚡" icon is displayed on remote controller. Press this button again to exit turbo function and "⚡" icon will disappear.

▲ / ▼ button

Press "▲" or "▼" button once increase or decrease set temperature 1°C(°F). Holding "▲" or "▼" button, 2s later, set temperature on remote controller will change quickly. On releasing button after setting is finished, temperature indicator on indoor unit will change accordingly.

When setting TIMER ON, TIMER OFF or CLOCK, press "▲" or "▼" button to adjust time. (Refer to CLOCK, TIMER ON, TIMER OFF buttons)

SLEEP button

Under cool or heat mode, press this button to start up sleep function.

"🌙" icon is displayed on remote controller.

Press this button again to cancel sleep function and "🌙" icon will disappear.

TEMP button

By pressing this button, you can see indoor set temperature, indoor ambient temperature or outdoor ambient temperature on indoor unit's display. The setting on remote controller is selected circularly as below:

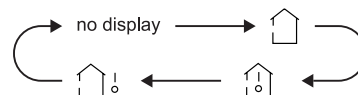

- When selecting "🏠" or no display with remote controller, temperature indicator on indoor unit displays set temperature.
- When selecting "🏠!" with remote controller, temperature indicator on indoor unit displays indoor ambient temperature.
- When selecting "🏠!" with remote controller, temperature indicator on indoor unit displays outdoor ambient temperature.

NOTE:

- Outdoor temperature display is not available for some models. At that time, indoor unit receives "🏠!" signal, while it displays indoor set temperature.
- It's defaulted to display set temperature when turning on the unit. There is no display in the remote controller.
- Only for the models whose indoor unit has dual-8 display.
- When selecting displaying of indoor or outdoor ambient temperature, indoor temperature indicator displays corresponding temperature and automatically turn to display set temperature after three or five seconds

WiFi button

Press "WiFi" button to turn on WiFi function, "WiFi" icon will be displayed on the remote controller.

Hold "WiFi" button for 5s to turn off WiFi function and "WiFi" icon will disappear.

Under off status, press "MODE" and "WiFi" buttons simultaneously for 1s, WiFi module will restore factory settings.

NOTE:

6. Function and Control

- This function is only available for some models.

button

Press this button to turn off display light on indoor unit. "☹️" icon on remote controller disappears.

Press this button again to turn on display light."☹️" icon is displayed.

button

Press this button to set clock time. "🕒" icon on remote controller will blink. Press "▲" or "▼" button within 5s to set clock time. Each pressing of "▲" or "▼" button, clock time will increase or decrease 1 minute. If hold "▲" or "▼" button, 2s later, time will change quickly. Release this button when reaching your required time. Press "CLOCK" button to confirm the time. "🕒" icon stops blinking.

NOTE:

- Clock time adopts 24-hour mode.
- The interval between two operations can't exceeds 5s. Otherwise, remote controller will quit setting status. Operation for TIMER ON/TIMER OFF is the same.

button

- **TIMER ON** button

"TIMER ON" button can set the time for timer on. After pressing this button, "🕒" icon disappears and the word "ON" on remote controller blinks. Press "▲" or "▼" button to adjust TIMER ON setting. After each pressing "▲" or "▼" button. TIMER ON setting will increase or decrease 1min. Holding "▲" or "▼" button, 2s later, the time will change quickly until reaching your required time. Press "TIMER ON" to confirm it. The word "ON" will stop blinking. "🕒" icon resumes displaying. Cancel TIMER ON: Under the condition that TIMER ON is started up, press "TIMER ON" button to cancel it.

- **TIMER OFF** button

"TIMER OFF" button can set the time for timer off. After pressing this button, "🕒" icon disappears and the word "OFF" on remote controller blinks. Press "▲" or "▼" button to adjust TIMER OFF setting. After each pressing "▲" or "▼" button, TIMER OFF setting will increase or decrease 1min. Holding "▲" or "▼" button, 2s later, the time will change quickly until reaching your required time.

Press "TIMER OFF" and the word "OFF" will stop blinking. "🕒" icon resumes displaying.

Cancel TIMER OFF. Under the condition that TIMER OFF is started up, press "TIMER OFF" button to cancel it.

NOTE:

- Under on and off status, you can set TIMER OFF or TIMER ON simultaneously.
- Before setting TIMER ON or TIMER OFF, please adjust the clock time.
- After starting up TIMER ON or TIMER OFF, set the constant circulating valid. After that, air conditioner will be turned on or turned off according to setting time."⏸️" button has no effect on setting. If you don't need this function, please use remote

controller to cancel it.

Function introduction for combination buttons

Energy-saving function

Under cooling mode, press "TEMP" and "CLOCK" buttons simultaneously to start up or turn off energy-saving function. When energy-saving function is started up, "SE" will be shown on remote controller, and air conditioner will adjust the set temperature automatically according to ex-factory setting to reach to the best energy-saving effect.

Press "TEMP" and "CLOCK" buttons simultaneously again to exit energy-saving function.

NOTE:

- Under energy-saving function, fan speed is defaulted at auto speed and it can't be adjusted.
- Under energy-saving function, set temperature can't be adjusted. Press "TURBO" button and the remote controller won't send signal.
- Sleep function and energy-saving function can't operate at the same time. If energy-saving function has been set under cool mode, press sleep button will cancel energy-saving function. If sleep function has been set under cool mode, start up the energy-saving function will cancel sleep function.

Auto clean function

Under unit off status, hold "MODE" and "FAN" buttons simultaneously for 5s to turn on or turn off the auto clean function. When the auto clean function is turned on, indoor unit displays "CL". During the auto clean process of evaporator, the unit will perform fast cooling or fast heating. There may be some noise, which is the sound of flowing liquid or thermal expansion or cold shrinkage. The air conditioner may blow cool or warm air, which is a normal phenomenon. During cleaning process, please make sure the room is well ventilated to avoid affecting the comfort.

NOTE:

- The auto clean function can only work under normal ambient temperature. If the room is dusty, clean it once a month; if not, clean it once every three months. After the auto clean function is turned on, you can leave the room. When auto clean is finished the air conditioner will enter standby status.
- This function is only available for some models.

8°C heating function

Under heat mode, press "TEMP" and "CLOCK" buttons simultaneously to start up or turn off 8°C heating function. When this function is started up, "🕒" and "8°C" will be shown on remote controller, and the air conditioner keep the heating status at 8°C. Press "TEMP" and "CLOCK" buttons simultaneously again to exit 8°C heating function.

NOTE:

- Under 8°C heating function, fan speed is defaulted at auto

6. Function and Control

speed and it can't be adjusted.

- Under 8°C heating function, set temperature can't be adjusted. Press "TURBO" button and the remote controller won't send signal.
- Sleep function and 8°C heating function can't operate at the same time. If 8°C heating function has been set under heat mode, press sleep button will cancel 8°C heating function. If sleep function has been set under heat mode, start up the 8°C heating function will cancel sleep function.
- Under °F temperature display, the remote controller will display 46°F heating.

Child lock function

Press "▲" or "▼" simultaneously to turn on or turn off child lock function. When child lock function is on, "🔒" icon is displayed on remote controller. If you operate the remote controller, the "🔒" icon will blink three times without sending signal to the unit.

Temperature display switchover function

Under OFF status, press "▼" and "MODE" buttons simultaneously to switch temperature display between °C and °F.

I FEEL function

Press "▲" and "MODE" buttons simultaneously to start I FEEL function and "🌡️" will be displayed on the remote controller. After this function is set, the remote controller will send the detected ambient temperature to the controller and the unit will automatically adjust the indoor temperature according to the detected temperature. Press this two buttons simultaneously again to close I FEEL function and "🌡️" will disappear.

Please put the remote controller near user when this function is set. Do not put the remote controller near the object of high temperature or low temperature in order to avoid detecting inaccurate ambient temperature.

When I FEEL function is turned on, the remote controller should be put within the area where indoor unit can receive the signal sent by the remote controller.

- The distance between signal sender and receiving window should be no more than 8m, and there should be no obstacles between them.
- Signal may be interfered easily in the room where there is fluorescent lamp or wireless telephone; remote controller should be close to indoor unit during operation.
- Replace new batteries of the same model when replacement is required.
- When you don't use remote controller for a long time, please take out the batteries.
- If the display on remote controller is fuzzy or there's no display, please replace batteries.

Replacement of batteries in remote controller

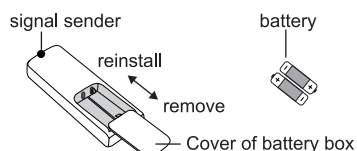

1. Press the back side of remote controller marked with "🔓" (OPEN), as shown in the fig, and then push out the cover of battery box along the arrow direction.
2. Replace two 7# (AAA 1.5V) dry batteries, and make sure the position of "+" polar and "-" polar are correct.
3. Reinstall the cover of battery box.

NOTICE:

- During operation, point the remote control signal sender at the receiving window on indoor unit.

6. Function and Control

6.2 GREE+ App Operation Manual

Control Flow Chart

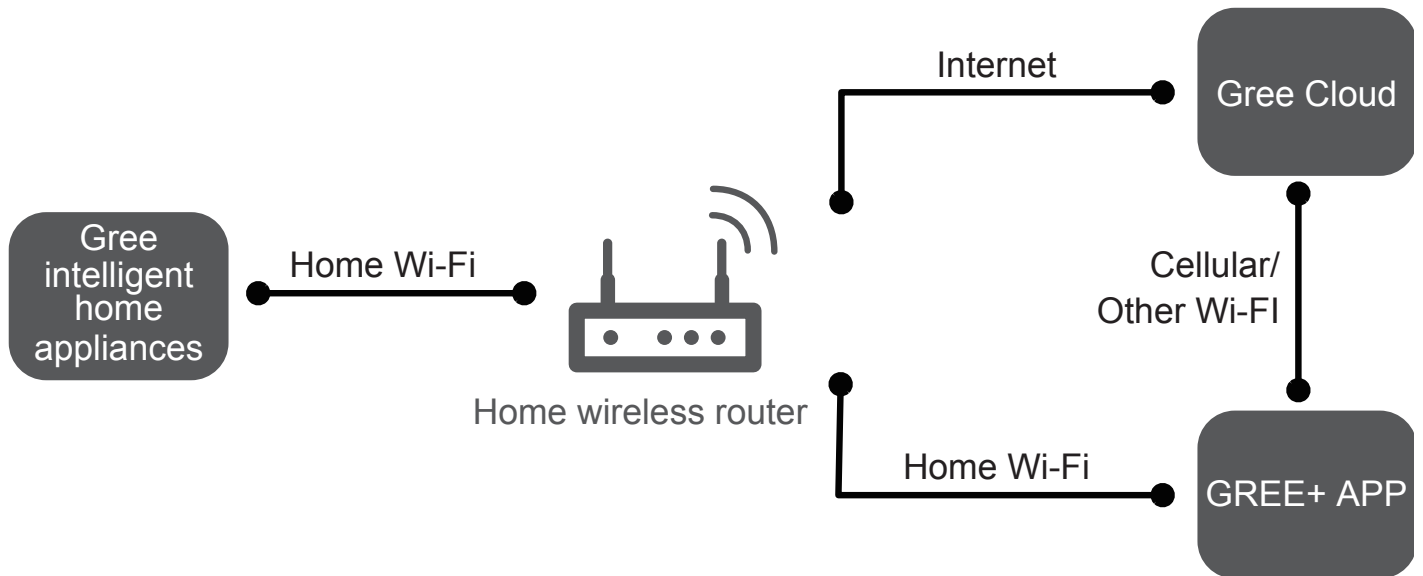

Operating Systems

Requirement for User's smart phone:

 iOS system
Support iOS7.0 and above version

 Android system
Support Android 4.4 and above version

Download and installation



GREE+ App Download Linkage

Scan the QR code or search "GREE+" in the application market to download and install it. When "GREE+" App is installed, register the account and add the device to achieve long-distance control and LAN control of Gree smart home appliances. For more information, please refer to "Help" in App.

6. Function and Control

6.3 Ewpe Smart App Operation Manual

Control Flow Chart

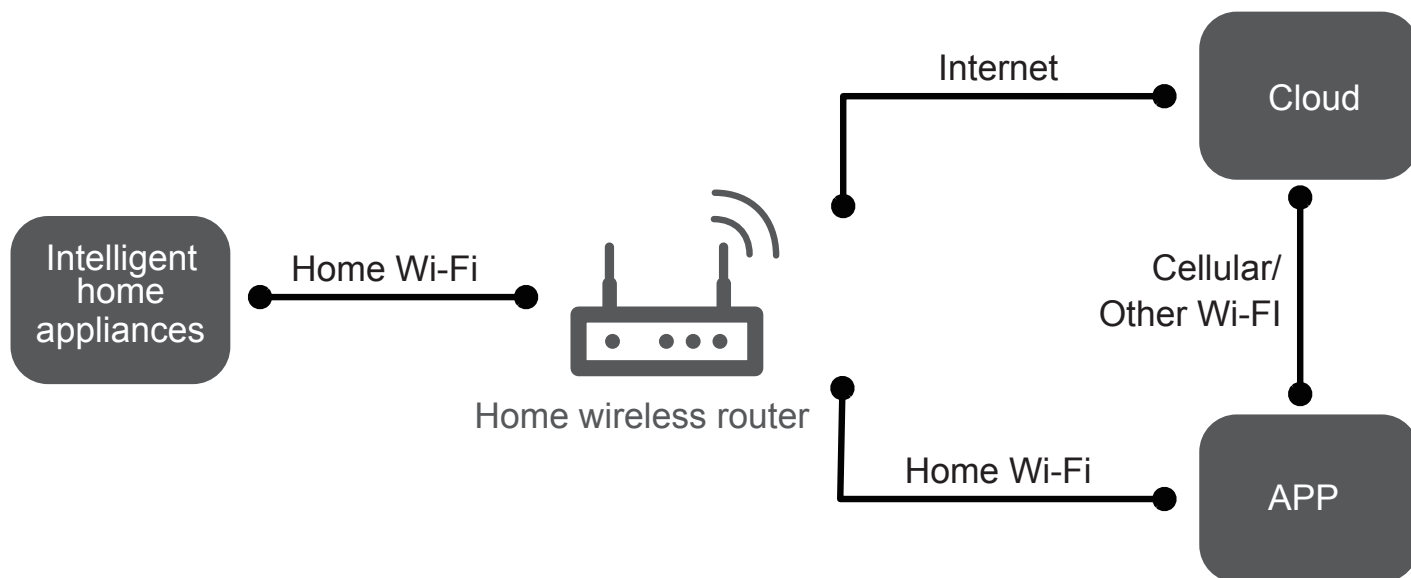

Operating Systems

Requirement for User's smart phone:



iOS system
Support iOS7.0 and above version



Android system
Support Android 4.4 and above version

Download and installation



App Download Linkage

Scan the QR code or search "Ewpe Smart" in the application market to download and install it. When "Ewpe Smart" App is installed, register the account and add the device to achieve long-distance control and LAN control of smart home appliances.

For more information, please refer to "Help" in App.

6. Function and Control

6.4 Brief Description of Modes and Functions

● Indoor Unit

1. Basic function of system

(1) Cooling mode

(1) Under this mode, fan and swing operates at setting status. Temperature setting range is 60.8~86.0°F.

(2) During malfunction of outdoor unit or the unit is stopped because of protection, indoor unit keeps original operation status.

(2) Drying mode

(1) Under this mode, fan operates at low speed and swing operates at setting status. Temperature setting range is 60.8~86.0°F.

(2) During malfunction of outdoor unit or the unit is stopped because of protection, indoor unit keeps original operation status.

(3) Protection status is same as that under cooling mode.

(4) Sleep function is not available for drying mode.

(3) Heating mode

(1) Under this mode, Temperature setting range is 60.8~86.0°F.

(2) Working condition and process for heating mode:

When turn on the unit under heating mode, indoor unit enters into cold air prevention status. When the unit is stopped or at OFF status, and indoor unit has been started up just now, the unit enters into residual heat-blowing status.

(4) Working method for AUTO mode:

1. Working condition and process for AUTO mode:

a. Under auto mode set temperature can be adjusted. The unit switch mode automatically according to ambient temperature.

2. Protection function

a. During cooling operation, protection function is same as that under cooling mode.

b. During heating operation, protection function is same as that under heating mode.

3. Display: Set temperature is the set value under each condition. Ambient temperature is (Tamb.-Tcompensation) for heat pump unit and Tamb. for cooling only unit.

4. If there's I feel function, Tcompensation is 0. Others are same as above.

(5) Fan mode

Under this mode, indoor fan operates at set fan speed. Compressor, outdoor fan, 4-way valve and electric heating tube stop operation. Indoor fan can select to operate at high, medium, low or auto fan speed. Temperature setting range is 60.8~86.0°F.

2. Other control

(1) Buzzer

Upon energization or availablely operating the unit or remote controller, the buzzer will give out a beep.

(2) Auto button

If press this auto button when turning off the unit, the complete unit will operate at auto mode. Indoor fan operates at auto fan speed and swing function is turned on. Press this auto button at ON status to turn off the unit.

(3) Auto fan

Heating mode: During auto heating mode or normal heating mode, auto fan speed will adjust the fan speed automatically according to ambient temperature and set temperature.

(4) Sleep function

After setting sleep function for a period of time, system will adjust set temperature automatically.

(5) Timer function

General timer and clock timer functions are compatible by equipping remote controller with different functions.

(6) Memory function

Memorize compensation temperature, off-peak energization value. Memory content: mode, up&down swing, light, set temperature, set fan speed, general timer (clock timer can't be memorized). After power recovery, the unit will be turned on automatically according to memory content.

(7) Health function

During operation of indoor fan, set health function by remote controller. Turn off the unit will also turn off health function.

Turn on the unit by pressing auto button, and the health is defaulted ON.

(8) I feel control mode

After controller received I feel control signal and ambient temperature sent by remote controller, controller will work according to the ambient temperature sent by remote controller.

(9) Compulsory defrosting function

a. Start up compulsory defrosting function

Under ON status, set heating mode with remote controller and adjust the temperature to 60.8°F. Press “+, -, +, -, +, - (▲, ▼, ▲, ▼, ▲, ▼,)” button successively within 5s and the complete unit will enter into compulsory defrosting status. Meanwhile, heating indicator on indoor unit will ON 10s and OFF 0.5s successively. (Note: If complete unit has malfunction or stops operation due to protection, compulsory defrosting function can be started up after malfunction or protection is resumed.

b. Exit compulsory defrosting mode

After compulsory defrosting is started up, the complete unit will exit defrosting operation according to the actual defrosting result, and the complete unit will resume normal heating operation.

(10) Refrigerant recovery function:

a. Enter refrigerant recycling function

6. Function and Control

Within 5min after energizing (unit ON or OFF status is ok), continuously press LIGHT button for 3 times within 3s to enter refrigerant recycling mode; Fo is displayed and refrigerant recycling function is started. At this moment, the maintenance people closes liquid valve. After 5min, stick the thimble of maintenance valve with a tool. If there is no refrigerant spraying out, close the gas valve immediately and then turn off the unit to remove the connection pipe.

b. Exit refrigerant recycling function

After entering refrigerant recycling mode, when receive any remote control signal or enter refrigerant recycling mode for 25min, the unit will exit refrigerant recycling mode automatically. If the unit is in standby mode before refrigerant recycling, it will be still in standby mode after finishing refrigerant recycling; if the unit is in ON status before refrigerant recycling, it will still run in original operation mode.

(11) Ambient temperature display control mode

a. When user set the remote controller to display set temperature (corresponding remote control code: 01), current set temperature will be displayed.

b. Only when remote control signal is switched to indoor ambient temperature display status (corresponding remote control code: 10) from other display status (corresponding remote control code: 00, 01,11), controller will display indoor ambient temperature for 3s and then turn back to display set temperature.

Under this mode, indoor fan operates at set fan speed. Compressor, outdoor fan, 4-way valve and electric heating tube stop operation. Indoor fan can select to operate at high, medium, low or auto fan speed. Temperature setting range is 60.8~86.0°F.

(12) Off-peak energization function:

Adjust compressors minimum stop time. The original minimum stop time is 180s and then we change to:

The time interval between two start-ups of compressor can't be less than $180+T$ s ($0 \leq T \leq 15$). T is the variable of controller. That's to say the minimum stop time of compressor is 180s~195s. Read-in T into memory chip when refurbish the memory chip each time. After power recovery, compressor can only be started up after $180+T$ s at least.

(13) SE control mode

The unit operates at SE status.

(14) X-fan mode

When X-fan function is turned on, after turn off the unit, indoor fan will still operate at low speed for 2min and then the complete unit will be turned off. When x-fan function is turned off, after turn off the unit, the complete unit will be turned off directly.

(15) 46.4°F heating function

Under heating mode, you can set 46.4°F heating function by remote controller. The system will operate at 46.4°F set temperature.

(16) Turbo fan control function

Set turbo function under cooling or heating mode to enter into turbo fan speed. Press fan speed button to cancel turbo wind.

No turbo function under auto, dry or fan mode.

(17) Auto cleaning function (only available on some models)

The automatic cleaning function of the indoor heat exchanger can be dedusted and sterilized by the condensation, frosting, defrosting and high temperature stages of the evaporator.

1. Under the power off, press and hold the "Internal Clean" button for 3 seconds while holding down the "MODE" and "FAN" buttons for 5 seconds to turn on the Auto Clean function. After the function is turned on, the air conditioner displays "CL".

2. The evaporator will be rapidly cooled or heated during the automatic cleaning process. There may be noise or even noise. The noise generated by the plastic parts due to thermal expansion and contraction is normal. During the cleaning and disinfection process, the room temperature may increase slightly, please keep the room well ventilated.

Tips:

The automatic cleaning function can only be started under normal environmental conditions. If the indoor environment is easy to dust, it is recommended to clean it once a month. If the indoor environment is not so dusty, it is recommended to clean it once every three months.

After turning on the automatic cleaning mode, the user can leave the room. When cleaning is complete, the unit will automatically enter standby mode.

6. Function and Control

● Outdoor Unit

09/12K

1. Cooling mode:

Working condition and process of cooling mode:

- ① When Tindoor ambient temperature $\geq T_{\text{preset}}$, unit enters into cooling mode. Indoor fan, outdoor fan and compressor start operation. Indoor fan operates according to set fan speed.
- ② When Tindoor ambient temperature $\leq T_{\text{preset}} - 2^{\circ}\text{C}$, compressor stops operation and outdoor fan will stop 30s later. Indoor fan operates according to set fan speed.
- ③ When $T_{\text{preset}} - 2^{\circ}\text{C} < \text{Tindoor ambient temperature} < T_{\text{preset}}$, unit operates according to the previous status.

Under cooling mode, 4-way valve is not energized. Temperature setting range is $16\sim 30^{\circ}\text{C}$. If compressor stops because of malfunction in cooling mode, indoor fan and swing motor will work according to the original status.

2. Drying mode

(1) Working condition and process of drying mode

- ① When Tindoor ambient temperature $> T_{\text{preset}}$, unit will be in drying mode. Outdoor fan and compressor start operation while indoor fan will operate at low fan speed.
- ② When $T_{\text{preset}} - 2^{\circ}\text{C} \leq \text{Tindoor ambient temperature} \leq T_{\text{preset}}$, unit operates according to the previous status.
- ③ When Tindoor ambient temperature $< T_{\text{preset}} - 2^{\circ}\text{C}$, compressor stops operation and outdoor fan will stop 30s later.

(2) Under drying mode, 4-way valve is not energized. Temperature setting range is $16\sim 30^{\circ}\text{C}$.

(3) Protection function: same as in cooling mode.

3. Fan mode

(1) Under this mode, indoor fan can select different fan speed (except Turbo) or auto fan speed. Compressor, outdoor fan and 4-way valve all stop operation.

(2) In fan mode, temperature setting range is $16\sim 30^{\circ}\text{C}$.

4. Heating mode

Working condition and process of heating mode:

- ① When $T_{\text{preset}} - (\text{Tindoor ambient temperature} - T_{\text{compensation}}) \geq 1^{\circ}\text{C}$, unit enters into heating mode. Compressor, outdoor fan and 4-way valve start operation.
- ② When $-2^{\circ}\text{C} < T_{\text{preset}} - (\text{Tindoor ambient temperature} - T_{\text{compensation}}) < 1^{\circ}\text{C}$, unit operates according to the previous status.
- ③ When $T_{\text{preset}} - (\text{Tindoor ambient temperature} - T_{\text{compensation}}) \leq -2^{\circ}\text{C}$, compressor stops operation and outdoor fan will stop 30s later. Indoor fan will be in residual-heat blowing status.
- ④ When unit is turned off under heating mode or changed to other modes from heating mode, 4-way valve will be power-off 2min after compressor stops working (compressor is in operation status under heating mode).

⑤ When Tindoor ambient temperature $> 30^{\circ}\text{C}$, compressor stops operation immediately. Outdoor fan will stop 30s later.

⑥ Under the condition that compressor is turned on, when unit is changed to heating mode from cooling or drying mode, 4-way valve will be energized in 2~3mins delay.

Note: Tcompensation is determined by IDU and ODU. If IDU controls the compensation temperature, then Tcompensation is determined according to the value sent by IDU to ODU; If IDU does not control the compensation temperature, then Tcompensation will default to 3°C by the ODU.

5. Freon recovery mode

After the Freon recovery signal from IDU is received, cooling at rated frequency will be forcibly turned on to recover Freon.

Indoor unit will display Fo. If any signal from remote controller is received, unit will exit from Freon recovery mode and indoor unit stops displaying Fo.

6. Compulsory defrosting

If unit is turned on under heating mode and set temperature is 16°C (by remote controller), press "+, -, +, -, +, -" within 5s, unit will enter into compulsory defrosting mode and send the signal to ODU. When the compulsory defrosting signal from ODU is received, IDU will exit from the compulsory defrosting mode and stop sending the signal to ODU.

After ODU receives the compulsory defrosting code, it will start compulsory defrosting. Defrosting frequency and opening angle will be the same as in normal defrosting mode. When compulsory defrosting is finished, the complete unit resume original status.

7. Auto mode

Auto mode is determined by controller of IDU. See IDU logic for details.

8. 8°C heating

Set temperature is 8°C . Display board of IDU displays 8°C . Under this mode, "Cold air prevention" function is shielded.

If compressor is operating under this mode, fan speed will adjust according to auto fan speed; if compressor stops operation under this mode, indoor fan will be in residual-heat blowing status.

When power on, communication light will be blinking in a normal way (after receiving a group of correct signals, blinking stops for 0.2s~0.3s). If theres no communication, communication light will be always on. If other ODU has malfunction, communication light will be on for 1s and off for 1s in a circular way.

6. Function and Control

18/24K

1. Input Parameter Compensation and Calibration

(1) Check the ambient temperature compensation function Indoor ambient temperature compensation function.

a. In cooling mode, the indoor ambient temperature participating in computing control = $(T_{\text{indoor ambient temperature}} - \Delta T_{\text{cooling indoor ambient temperature compensation}})$

b. In heating mode, the indoor ambient temperature participating in computing control = $(T_{\text{indoor ambient temperature}} - \Delta T_{\text{heating indoor ambient temperature compensation}})$

(2) Check effective judgment controls of parameters

Effective judgment function of the outdoor exhaust temperature thermo-bulb When conditions a and b are satisfied, the outdoor exhaust temperature thermo-bulb is judged not to be connected into place, the mainboard of outer units will display failure of the outdoor exhaust temperature thermo-bulb (not connected into place), stop the machine for repairing, and resume the machine by remote controls of ON/OFF.

a. Judgment of exhaust detection temperature change:

After the compressor starts up and runs for 10 minutes, if the compressor frequency $f \geq 40\text{Hz}$, and the rising value T_{exhaust} (T_{exhaust} (after start-up for 10 minutes) - T_{exhaust} (before start-up)) $< 35.6^\circ\text{F}$, the outdoor exhaust temperature thermo-bulb can be judged not to be connected into place (judging once when the power is on the first time)

b. Comparative judgment of exhaust detection temperature and condenser detection temperature ($T_{\text{pipe temperature}} = T_{\text{outdoor pipe temperature in cooling mode}}$, $T_{\text{pipe temperature}} = T_{\text{indoor pipe temperature in heating mode}}$):

After the compressor starts up and runs for 10 minutes, if the compressor frequency $f \geq 40\text{Hz}$, and $T_{\text{pipe temperature}} \geq (T_{\text{exhaust}} + 37.4)$, the outdoor exhaust temperature thermobulb can be judged not to be connected into place (judging once when power is on the first time)

2. Basic Functions

(1) Cooling Mode

1. Conditions and processes of cooling operation:

(1) If the compressor is shut down, and $[T_{\text{setup}} - (T_{\text{indoor ambient temperature}} - \Delta T_{\text{cooling indoor ambient temperature compensation}})] \leq 32.9^\circ\text{F}$, start up the machine for cooling, the cooling operation will start;

(2) During operations of cooling, if $32^\circ\text{F} \leq [T_{\text{setup}} - (T_{\text{indoor ambient temperature}} - \Delta T_{\text{cooling indoor ambient temperature compensation}})] < 35.6^\circ\text{F}$, the cooling operation will be still running;

(3) During operations of cooling, if $35.6^\circ\text{F} \leq [T_{\text{setup}} - (T_{\text{indoor ambient temperature}} - \Delta T_{\text{cooling indoor ambient temperature compensation}})]$, the cooling operation will stop after reaching the temperature point.

2. Temperature setting range

(1) If $T_{\text{outdoor ambient temperature}} \geq [T_{\text{low-temperature cooling temperature}}]$, the temperature can be set at: $60.8\sim 86^\circ\text{F}$ (Cooling at room temperature);

(2) If $T_{\text{outdoor ambient temperature}} < [T_{\text{low-temperature cooling temperature}}]$, the temperature can be set at: $77\sim 86^\circ\text{F}$ (Cooling at low temperature),

that is, the minimum setting temperature for outer units judgment is 77°F .

(2) Dehumidifying Mode

1. Conditions and processes of dehumidifying operations: Same as the cooling mode;

2. The temperature setting range is: $60.8\sim 86^\circ\text{F}$;

(3) Air-supplying Mode

1. The compressor, outdoor fans and four-way valves are switched off;

2. The temperature setting range is: $60.8\sim 86^\circ\text{F}$.

(4) Heating Mode

1. Conditions and processes of heating operations: ($T_{\text{indoor ambient temperature}}$ is the actual detection temperature of indoor environment thermo-bulb, $T_{\text{heating indoor ambient temperature compensation}}$ is the indoor ambient temperature compensation during heating operations)

(1) If the compressor is shut down, and $[(T_{\text{indoor ambient temperature}} - \Delta T_{\text{heating indoor ambient temperature compensation}}) - T_{\text{setup}}] \leq 32.9^\circ\text{F}$, start the machine to enter into heating operations for heating;

(2) During operations of heating, if $32^\circ\text{F} \leq [(T_{\text{indoor ambient temperature}} - \Delta T_{\text{heating indoor ambient temperature compensation}}) - T_{\text{setup}}] < 35.6^\circ\text{F}$, the heating operation will be still running;

(3) During operations of heating, if $35.6^\circ\text{F} \leq [(T_{\text{indoor ambient temperature}} - \Delta T_{\text{heating indoor ambient temperature compensation}}) - T_{\text{setup}}]$, the heating operation will stop after reaching the temperature point.

2. The temperature setting range in this mode is: $60.8\sim 86^\circ\text{F}$.

3. Special Functions

Defrosting Control

① Conditions for starting defrosting

After the time for defrosting is judged to be satisfied, if the temperature for defrosting is satisfied after detections for continuous 3minutes, the defrosting operation will start.

② Conditions of finishing defrostin

The defrosting operation can exit when any of the conditions below is satisfied

③ $T_{\text{outdoor pipe temperature}} \geq (T_{\text{outdoor ambient temperature}} - [T_{\text{temperature 1 of finishing defrostin}}])$;

④ The continuous running time of defrosting reaches $[t_{\text{max. defrosting time}}]$.

4. Control Logic

(1) Compressor Control

Start the compressor after starting cooling, heating, dehumidifying operations, and the outer fans start for 5s; When the machine is shutdown, in safety stops and when switching to air-supplying mode, the compressor will stop immediately. In all modes: once the compressor starts up, it will not be allowed to stop until having run for the $[t_{\text{min. compressor running time}}]$ (Note: including cases of shutdown when the temperature point is reached; except the cases requiring stopping the compressor such as fault protection, remote shutdown, mode switching etc.); In all modes: once the compressor stops, it will be allowed be restart after 3-minute delay (Note: The indoor units have a function of power memory,

6. Function and Control

the machine can be restarted after remote shutdown and powering up again without delay).

1. Cooling mode

Start the machine to enter into cooling operation for cooling, the compressor is switched on.

2. Dehumidifying mode

Same as the cooling mode.

3. Air-supplying mode

The compressor is switched off.

4. Heating mode

(1) Start the machine to enter into heating operation for heating, the compressor is switched on.

(2) Defrosting:

a. Defrosting starts: the compressor is shut down, and restarts it after 55-second delay.

b. Defrosting ends: the compressor stops, then starts it after 55-second delay.

(2) Outer Fans Control

Notes:

Only the outer fans run for at least 80s in each air flow speed can the air flow be switched

After the outer fans run compulsively in high speed for 80s when the machine starts up, control the air flow according to the logic

After remote shutdown, safety stops, and when the machine stops after reaching the temperature point, as well as after the compressor stops, extend 1 minute, the outer fans will stop (During the period in the 1 minute, the air flow of outer fans can be changed according to the outdoor ambient temperature changes); When running with force, the outdoor fans shall run in the highest air flow.

(3) 4-way valve control

1. The 4-way valve control under the modes of Cooling, dehumidification and supplying air: closing

2. The status of 4-way valve control under the heating mode: getting power;

(1) 4-way valve power control under heating mode

a. Starts the machine under heating mode, the 4-way valve will get power immediately.

(2) 4-way valve power turn-off control under heating mode

a. When you should turn off the power or switch to other mode under heating mode, the power of 4-way valve will be cut after 2 minutes of the compressor stopped.

b. When all kinds of protection stops, the power of 4-way valve will be cut after delaying 4 minutes.

(3) Defrosting control under heating mode:

a. Defrosting begins: The power of 4-way valve will be cut after 50s of entering into the defrosting compressor.

b. Defrosting stops: The 4-way valve will get power after 50s of exiting the defrosting compressor.

(4) Evaporator frozen-preventing protection function

At the mode of Cooling, dehumidifying:

Evaporator frozen-preventing protection function is allowed to

begin after 6 min of starting the compressor.

1. Starting estimation:

After the compressor stopped working for 180s, if $T_{\text{inner pipe}} > [T_{\text{frozen-preventing frequency-limited temperature}}]$ (the temperature of hysteresis is 35.6°F), the machine is only allowed to start for operating, otherwise it should not be started, and should be stopped to treat according to the frozen-preventing protection: Clear the trouble under the mode of power turn-off / heating, and the protection times are not counted.

2. Frequency limited

If $[T_{\text{frozen-preventing normal speed frequency-reducing temperature}}] \leq [T_{\text{inner pipe}} T_{\text{frozen-preventing frequency-limited temperature}}]$, you should limit the frequency raising of compressor.

3. Reducing frequency at normal speed:

If $[T_{\text{frozen-preventing high speed frequency-reducing temperature}}] \leq [T_{\text{inner pipe}} T_{\text{frozen-preventing normal speed frequency-reducing temperature}}]$, you should adjust the compressor frequency by reducing 8Hz/90s till the lower limit;

4. Reducing frequency at high speed:

If $[T_{\text{frozen-preventing power turn-off temperature}}] \leq T_{\text{inner pipe}} [T_{\text{frozen-preventing high speed frequency-reducing temperature}}]$ you should adjust the compressor frequency by reducing 30Hz/90s till the lower limit;

5. Power turn-off:

If the $T_{\text{inner pipe}} < [T_{\text{frozen-preventing power turn-off temperature}}]$, then frozen-preventing protect to stop the machine; If $T_{\text{frozen-preventing frequency-limited temperature}} < T_{\text{inner pipe}}$, and the compressor has stopped working for 3 minutes, the whole machine should be allowed to operate.

6. If the frozen-preventing protection power turn-off continuously occurs for six times, it should not be resumed automatically, and you should press the ON/OFF button to resume if the fault keeps on. During the process of running, if the running time of compressor exceeds the t evaporator frozen-preventing protection times zero clearing time, the times of frozen-preventing power turn-off should be cleared to recount. The mode of stopping the machine or transferring to supply air will clear the trouble times immediately (if the trouble can not be resumed, mode transferring will not clear it).

(5) Overload protection function

Overload protection function at the mode of Cooling and dehumidifying

1. Starting estimation:

After the compressor stopped working for 180s, if $T_{\text{outer pipe}} < [T_{\text{Cooling overload frequency-limited temperature}}]$ (the temperature of hysteresis is 35.6°F), the machine is allowed to start, otherwise it should not be started, and should be stopped to treat according to the overload protection: Clear the trouble at the mode of power turn-off / heating, and the protection times are not counted.

2. Frequency limited

If $[T_{\text{Cooling overload frequency-limited temperature}}] \leq [T_{\text{outer pipe}} T_{\text{Cooling overload frequency reducing temperature at normal speed}}]$, you should limit the frequency raising of compressor.

3. Reducing frequency at normal speed and power turn-off:

If $[T_{\text{Cooling overload frequency reducing temperature at high speed}}] \leq T_{\text{outer pipe}} < [T_{\text{Cooling}}$

6. Function and Control

overload power turn-off temperature], you should adjust the compressor frequency by reducing 8Hz/90s till the lower limit; After it was running 90s at the lower limit, if $[T_{\text{Cooling overload frequency reducing temperature at normal speed}}] \leq T_{\text{outer pipe}}$, then Cooling overload protects machine stopping;

4. Reducing frequency at high speed and stop machine:

If $[T_{\text{Cooling overload frequency reducing temperature at high speed}}] \leq T_{\text{outer pipe}}$ $[T_{\text{Cooling overload power turn-off temperature}}]$, you should adjust the compressor frequency by reducing 30Hz/90s till the lower limit; After it was running 90s at the lower limit, if $[T_{\text{Cooling overload frequency reducing temperature at normal speed}}] \leq [T_{\text{outer pipe}}]$, then Cooling overload protects machine stopping;

5. Power turn-off:

If the $[T_{\text{Cooling overload power turn-off temperature}}] \leq T_{\text{outer pipe}}$, then Cooling overload protects machine stopping; If $[T_{\text{outer pipe}}] < [T_{\text{Cooling overload frequency-limited temperature}}]$ and the compressor has been stopped working for 3 minutes, the machine should be allowed to operate.

6. If the Cooling overload protection power turn-off continuously occurs for six times, it should not be resumed automatically, and you should press the ON/OFF button to resume if the fault keeps on. During the process of running, if the running time of compressor exceeds the t overload protection times zero clearing time, the times of overload protection power turn-off should be cleared to recount. The mode of stopping the machine or transferring to supply air will clear the trouble times immediately (if the trouble can not be resumed, transferring mode will not clear it).

Overload protection function at the mode of heating

Starting estimation :

After the compressor stopped working for 180s, if T inner pipe T heating overload frequency-limited temperature (the temperature of hysteresis is 35.6°F), the machine is allowed to start, otherwise it should not be started, and should be stopped to treat according to the overload protection:

Clear the trouble at the mode of power turn-off / heating, and the protection times are not counted.

1. Frequency limited

If $[T_{\text{heating overload frequency-limited temperature}}] \leq T_{\text{inner pipe}} < [T_{\text{heating overload frequency reducing temperature at normal speed}}]$, you should limit the frequency raising of compressor.

2. Reducing frequency at normal speed and stopping machine:

If $[T_{\text{heating overload frequency reducing temperature at normal speed}}] \leq T_{\text{inner pipe}} < [T_{\text{heating overload frequency reducing temperature at high speed}}]$, you should adjust the compressor frequency by reducing 8Hz/90s till the lower limit; After it was running 90s at the lower limit, if T heating overload frequency reducing temperature at normal speed $\leq T_{\text{inner pipe}}$, then overload protects machine stopping;

3. Reducing frequency at high speed and power turn-off:

If $[T_{\text{heating overload frequency reducing temperature at high speed}}] \leq T_{\text{inner pipe}} < [T_{\text{heating overload power turn-off temperature}}]$, you should adjust the compressor frequency by reducing 30Hz/90s till the lower limit; After it was running 90s at the lower limit, if T heating overload frequency

reducing temperature at normal speed $\leq T_{\text{outer pipe}}$, then Cooling overload protects machine stopping;

4. Power turn-off:

If the $[T_{\text{heating overload power turn-off temperature}}] \leq T_{\text{inner pipe}}$, then overload protects machine stopping; If T inner pipe T heating overload frequency-limited temperature and the compressor has been stopped working for 3 minutes, the machine should be allowed to operate.

5. If the overload protection power turn-off continuously occurs for six times, it should not be resumed automatically, and you should press the ON/OFF button to resume if the fault keeps on. During the process of running, if the running time of compressor exceeds the t overload protection times zero clearing time, the times of overload protection power turn-off should be cleared to recount. The mode of stopping the machine or transferring to supply air will clear the trouble times immediately (if the trouble can not be resumed, transferring mode will not clear it). Protective function for discharge temperature of compressor

1. Starting estimation:

After the compressor stopped working for 180s, if $T_{\text{Discharge}} < T_{\text{Discharge limited temperature}}$ (the temperature of hysteresis is 35.6°F), the machine is allowed to start, otherwise it should not be started, and should be stopped to treat according to the discharge temperature:

The machine should be stopped or transferred to supply air, the trouble should be cleared immediately, and the protection times are not counted.

2. Frequency limited

If $[T_{\text{limited frequency temperature during discharging}}] \leq T_{\text{Discharge}} < [T_{\text{frequency reducing temperature at normal speed during discharging}}]$, you should limit the frequency raising of compressor.

3. Reducing frequency at normal speed and stopping machine:

If $[T_{\text{frequency reducing temperature at normal speed during discharging}}] \leq T_{\text{Discharge}} < [T_{\text{frequency reducing temperature at high speed during discharging}}]$, you should adjust the compressor frequency by reducing 8Hz/90s till the lower limit; After it was running 90s at the lower limit, if $[T_{\text{frequency reducing temperature at normal speed during discharging}}] \leq T_{\text{Discharge}}$, you should discharge to protect machine stopping;

4. Reducing frequency at high speed and power turn-off:

If $[T_{\text{frequency reducing temperature at high speed during discharging}}] \leq T_{\text{Discharge}} < [T_{\text{Stop temperature during discharging}}]$, you should adjust the compressor frequency by reducing 30Hz/90s till the lower limit; After it was running 90s at the lower limit, if $[T_{\text{frequency reducing temperature at normal speed during discharging}}] \leq T_{\text{Discharge}}$, you should discharge to protect machine stopping;

5. Power turn-off:

If the $[T_{\text{Power turn-off temperature during discharging}}] \leq T_{\text{Discharge}}$, you should discharge to protect machine stopping; If $[T_{\text{Discharge}}] < [T_{\text{limited frequency temperature during discharging}}]$ and the compressor has been stopped for 3 minutes, the machine should be allowed to operate.

6. If the discharging temperature protection of compressor continuously occurs for six times, it should not be resumed

6. Function and Control

automatically, and you should press the ON/OFF button to resume. During the process of running, if the running time of compressor exceeds the $t_{\text{Protection times clearing of discharge}}$, the discharge protection is cleared to recount. Stopped or transferred to supply air mode will clear the trouble times immediately (if the trouble can not be resumed, mode transferring also will not clear it).

7. Frequency limited

If $[I_{\text{Limited frequency when overcurrent}}] \leq [I_{\text{AC Electric current}}] < [I_{\text{frequency reducing when overcurrent}}]$, you should limit the frequency raising of compressor.

8. Reducing frequency:

If $[I_{\text{Frequency reducing when overcurrent}}] \leq [I_{\text{AC Electric current}}] \text{ I Power turn-off when overcurrent}$, you should reduce the compressor frequency till the lower limit or exit the frequency reducing condition;

9. Power turn-off:

If $[I_{\text{Power turn-off machine when overcurrent}}] \leq [I_{\text{AC Electric current}}]$, you should carry out the overcurrent stopping protection; If $I_{\text{AC Electric current}} < [T_{\text{Limited frequency when overcurrent}}]$ and the compressor has been stopped for 3 minutes, the machine should be allowed to operate.

10. If the overcurrent protection continuously occurs for six times, it should not be resumed automatically, and you should press the ON/OFF button to resume. During the process of running, if the running time of compressor exceeds the $[t_{\text{Protection times clearing of over current}}]$, the discharge protection is cleared to recount.

(6) Voltage sag protection

After start the compressor, if the time of DC link Voltage sag $[U_{\text{Sagging protection voltage}}]$ is measured to be less than $t_{\text{Voltage sag protection time}}$, the machine should be stop at once, hand on the voltage sag trouble, reboot automatically after 30 minutes.

(7) Communication fault

When you have not received any correct signal from the inner machine in three minutes, the machine will stop for communication fault. When you have not received any correct signal from driver IC (aim to the controller for the separating of main control IC and driver IC), and the machine will stop for communication fault. If the communication is resumed, the machine will be allowed to operate.

(8) Module protection

Testing the module protective signal immediately after started, once the module protective signal is measured, stop the machine with module protection immediately. If the module protection is resumed, the machine will be allowed to operate. If the module protection continuously occurs for three times, it should not be resumed automatically, and you should press the ON/OFF button to resume. If the running time of compressor exceeds the $[t_{\text{Protection times clearing of module}}]$, the module protection is cleared to recount.

(9) Module overheating protection

1. Starting estimation:

After the compressor stopped working for 180s, if $T_{\text{Module}} < [T_{\text{Module frequency limited temperature}}]$ (the temperature of hysteresis is 35.6°F), the machine is allowed to start, otherwise it should not be started, and should be stopped to treat according to the module overheating protection: The machine should be stopped or transferred to

supply air, the trouble should be cleared immediately, and the protection times are not counted.

2. Frequency limited

If $[T_{\text{Limited frequency temperature of module}}] \leq T_{\text{Module}} < [T_{\text{frequency reducing temperature at normal speed of module}}]$, you should limit the frequency raising of compressor.

3. Reducing frequency at normal speed and power turn-off:

If $[T_{\text{frequency reducing temperature at normal speed of module}}] \leq T_{\text{Module}} < [T_{\text{frequency reducing temperature at high speed of module}}]$, you should adjust the compressor frequency by reducing 8Hz/90s till the lower limit; After it was running 90s at the lower limit, if $[T_{\text{frequency reducing temperature at normal speed of module}}] \leq T_{\text{Module}}$, you should stop the machine for module overheating protection;

4. Reducing frequency at high speed and power turn-off:

If $[T_{\text{frequency reducing temperature at high speed of module}}] \leq T_{\text{Module}} < [T_{\text{Power turn-off temperature of module}}]$ you should adjust the compressor frequency by reducing 30Hz/90s till the lower limit; After it was running 90s at the lower limit, if $[T_{\text{frequency reducing temperature at normal speed of module}}] \leq T_{\text{Module}}$, you should stop the machine for module overheating protection;

5. Power turn-off:

If the $[T_{\text{Power turn-off temperature of module}}] \leq T_{\text{Module}}$, you should stop the machine for module overheating protection; If $T_{\text{Module}} < [T_{\text{Limited frequency temperature of module}}]$ and the compressor has been stopped for 3 minutes, the machine should be allowed to operate.

6. If protection continuously occurs for six times, it should not be resumed automatically, and you should press the ON/OFF button to resume. During the process of running, if the running time of compressor exceeds the $[t_{\text{Protection times clearing of module}}]$, the discharge protection is cleared to recount. Stopped or transferred to supply air mode will clear the trouble times immediately (if the trouble can not be resumed, mode transferring also will not clear it).

(10) Compressor overloads protection

If you measure the compressor overload switch action in 3s, the compressor should be stopped for overloading. The machine should be allowed to operate after overload protection was measured to resume. If the overloading protection continuously occurs for three times, it should not be resumed automatically, and you should press the ON/OFF button to resume. The protection times of compressor is allowed to clear after the compressor run $[t_{\text{Protection times clearing of compressor overloading}}]$ 30 minutes.

(11) Phase current overcurrent protection of compressor

During the running process of compressor, you could measure the phase current of the compressor, and control it according to the following steps:

1. Frequency limited

If $[I_{\text{Limited frequency phase current}}] \leq [I_{\text{Phase current T frequency reducing phase current}}]$, you should limit the frequency raising of compressor.

2. Reducing Frequency

If $[I_{\text{Frequency Reducing Phase Current}}] \leq [I_{\text{Phase Current}}] < [I_{\text{Power Turn-Off Phase Current}}]$, the compressor shall continue to reduce frequency till the lowest frequency limit or out of the condition of reducing frequency;

3. Power turn-off

If $[I_{\text{Phase Current}}] \geq [I_{\text{Power Turn-Off Phase Current}}]$, the compressor phase current shall stop working for overcurrent protection; if $[I_{\text{Phase Current}}] \leq [I_{\text{Phase Current}}]$

6. Function and Control

Frequency Reducing Phase Current], and the compressor have stopped working for 3 min, the machine shall be allowed to operate;

4. If the overcurrent protection of compressor phase current continuously occurs for six times, it should not be resumed automatically, and you should press the ON/OFF button to resume. During the process of running, if the running time of compressor exceeds the [t_{Clearing Time of Compressor Phase Current Times}], the overcurrent protection is cleared to recount.

(12) Starting-up Failure Protection for Compressor

Stop the compressor after its starting-up fails, restart it after 20s if the fault doesn't show, and if they are all failing for the successive start 3 times, it shall be reported as Starting-up Failure, and then restart up it after 3 min. When it still not be able to operate through carry out the above process for 5 times, it is available if press ON/OFF. And the compressor should be cleared the times after it run 2 min.

(13) Out-of-Step Protection for Compressor

The out-of-step protection signal should be detected immediately after starting-up compressor, and once find the out-of-step protection signal, the out-of-step protection shall be stopped; if it can run for lasting power turn-off 3 min, the machine shall be allowed to operate. If it still can't run automatically when the out-of-step protection for compressor happens to stop working for 6 times in succession, it needs to press ON/OFF to operate. And if the running time is more than 10 min, the power turn-off times for out-of-step protection shall be cleared and recounted.

(14) Voltage Abnormity Protection for DC Bus

To detect voltage abnormity protection for dc bus after completing the pre-charge:

1. Over-High Voltage Protection for DC Bus:

If it found the DC bus voltage $U_{DC} > [U_{DC}^{\text{Jiekuangchun Protection}}]$, turn off PFC and stop the compressor at once, and it shall show the DC over-high voltage failure; it should clear out the failure when the voltage dropped to $U_{DC} < [U_{DC}^{\text{Jiekuangchun Recovery}}]$ and the compressor stopped for 3 min.

2. Over-Low Voltage Protection for DC Bus:

If it found the DC bus voltage $U_{DC} < [U_{DC}^{\text{Wantuochun Protection}}]$, turn off PFC and stop the compressor at once, and it shall show the DC over-low voltage; and it should clear out the failure when the voltage raised to $U_{DC} > [U_{DC}^{\text{Wantuochun Recovery}}]$ and the compressor stopped for 3 min.

3. To detect voltage abnormity protect for DC bus when getting electricity:

If it found the DC bus voltage $U_{DC} > [U_{DC}^{\text{Over-High Voltage}}]$, turn off the relay at once, and shows voltage abnormity failure for DC Bus. And the failure can't recover except to break off and get the electricity.

(15) Abnormity Protection for Four-way Valve

Under the model of heating operation in good condition: the compressor is detected $[T_{\text{Inner Tube}} < (T_{\text{Inner Ring}} - T_{\text{Abnormity Temperature Difference}}^{\text{For Four-Way Valve Reversion}})]$, during the running, it should be regarded as four-way valve reversion abnormity. And then it can run if stop the reversion abnormity protection for four-way valve 3 min; and

if it still can't run when the reversion abnormity protection for four-way valve happens to stop working for 3 times in succession, it is available if presses ON/OFF.

Attention: the protection shall be shielded during the testing mode and defrosting process, and it shall be cleared out the failure and its times immediately when turning off or delivering wind / cooling / dehumidifying mode conversed (the inverted mode don't clear out the failure when it can't recover to operate).

(16) PFC Protection

1. After start up the PFC, it should detect the protection signal of PFC immediately; under the condition of PFC protection, it should turn off the PFC and compressor at one time;

2. It shows the failure is cleared out if PFC Protection stopped working 3 min and recovers to run automatically;

3. If it still can't run when it occurs PFC protection for 3 times in succession, it is available if presses ON/OFF; and clear the PFC Protection times when start up PFC for 10min.

(17) Failure Detection for Sensor

1. Outdoor Ambient Sensor: detect the failure of sensor at all times.

2. Outdoor Tube Sensor: You should not detect the failure of outdoor tube sensor within 10 minutes heating operation compressor except the defrosting, and you could detect it at other time.

3. Outdoor Exhaust Sensor:

(a) The compressor only detect the sensor failure after it start up 3 min in normal mode;

(b) It should detect the exhaust sensor failure immediately in the testing mode.

4. Module Temperature Sensor:

(a) Short-Circuit Detection: the compressor should be detected immediately when the module temperature sensor occurs short-circuits;

(b) Open-Circuit Detection: the compressor should be detected on open-circuit when it runs 3min (it needn't 30s avoiding the module over-heated).

(c) Detect the sensor failure at all times in the testing mode.

5. Disposal for Sensor Protection

(1) When the short-circuit of sensor is detected within 30s, It is regarded as the temperature of sensor over-high (or infinitely high), and now according to the over-high sensor, the machine should carry out the corresponding protection to stop working, and show the corresponding temperature shutdown protection and sensor failure at the same time (for example: the compressor stops immediately when the outdoor tube sensor short-circuit, and the machine shall show the overload protection and outdoor tube sensor failure).

(2) When the open-circuit of sensor is detected within 30s, The protection shall be stopped and it shall show the corresponding sensor failure.

6. Electric Heating Function of Chassis

(1) When $T_{\text{outdoor amb}} \leq 32^{\circ}\text{F}$, the electric heating of chassis will operate;

6. Function and Control

(2) When Toutdoor amb.>35.6°F , the electric heating of chassis will stop operation;

(3)When 32°F <Toutdoor amb.≤35.6°F, the electric heating of chassis will keep original status.

7. Electric Heating Function of Compressor

(1) When Toutdoor amb.≤23°F , compressor stops operation, while the electric heating of compressor starts operation;

(2) When Toutdoor amb.>28.4°F , the electric heating of compressor stops operation;

(3) When 23°F <Toutdoor amb.≤28.4°F , the electric heating of compressor will keep original status.

6. Electric Heating Function of Chassis

(1) When Toutdoor amb.≤32°F , the electric heating of chassis will operate;

(2) When Toutdoor amb.>35.6°F , the electric heating of chassis will stop operation;

(3)When 32°F <Toutdoor amb.≤35.6°F, the electric heating of chassis will keep original status.

7. Electric Heating Function of Compressor

(1) When Toutdoor amb.≤23°F , compressor stops operation, while the electric heating of compressor starts operation;

(2) When Toutdoor amb.>28.4°F , the electric heating of compressor stops operation;

(3) When 23°F <Toutdoor amb.≤28.4°F , the electric heating of compressor will keep original status.

7. Notes for Installation and Maintenance

Safety Precautions: Important!

Please read the safety precautions carefully before installation and maintenance.

The following contents are very important for installation and maintenance.

Please follow the instructions below.

- The installation or maintenance must accord with the instructions.
- Comply with all national electrical codes and local electrical codes.
- Pay attention to the warnings and cautions in this manual.
- All installation and maintenance shall be performed by distributor or qualified person.
- All electric work must be performed by a licensed technician according to local regulations and the instructions given in this manual.
- Be caution during installation and maintenance. Prohibit incorrect operation to prevent electric shock, casualty and other accidents.

WARNINGS

Electrical Safety Precautions:

1. Cut off the power supply of air conditioner before checking and maintenance.
2. The air condition must apply specialized circuit and prohibit share the same circuit with other appliances.
3. The air conditioner should be installed in suitable location and ensure the power plug is touchable.
4. Make sure each wiring terminal is connected firmly during installation and maintenance.
5. Have the unit adequately grounded. The grounding wire can't be used for other purposes.
6. Must apply protective accessories such as protective boards, cable-cross loop and wire clip.
7. The live wire, neutral wire and grounding wire of power supply must be corresponding to the live wire, neutral wire and grounding wire of the air conditioner.
8. The power cord and power connection wires can't be pressed by hard objects.
9. If power cord or connection wire is broken, it must be replaced by a qualified person.
10. If the power cord or connection wire is not long enough, please get the specialized power cord or connection wire from the manufacture or distributor. Prohibit prolong the wire by yourself.
11. For the air conditioner without plug, an air switch must

be installed in the circuit. The air switch should be all-pole parting and the contact parting distance should be more than 3mm.

12. Make sure all wires and pipes are connected properly and the valves are opened before energizing.
13. Check if there is electric leakage on the unit body. If yes, please eliminate the electric leakage.
14. Replace the fuse with a new one of the same specification if it is burnt down; Don't replace it with a cooper wire or conducting wire.
15. If the unit is to be installed in a humid place, the circuit breaker must be installed.

Installation Safety Precautions:

1. Select the installation location according to the requirement of this manual.(See the requirements in installation part)
2. Handle unit transportation with care; the unit should not be carried by only one person if it is more than 20kg.
3. When installing the indoor unit and outdoor unit, a sufficient fixing bolt must be installed; make sure the installation support is firm.
4. Ware safety belt if the height of working is above 2m.
5. Use equipped components or appointed components during installation.
6. Make sure no foreign objects are left in the unit after finishing installation.

Refrigerant Safety Precautions:

1. When refrigerant leaks or requires discharge during installation, maintenance, or disassembly, it should be handled by certified professionals or otherwise in compliance with local laws and regulations.
2. Avoid contact between refrigerant and fire as it generates poisonous gas; Prohibit prolong the connection pipe by welding.
3. Apply specified refrigerant only. Never have it mixed with any other refrigerant. Never have air remain in the refrigerant line as it may lead to rupture or other hazards.
4. Make sure no refrigerant gas is leaking out when installation is completed.
5. If there is refrigerant leakage, please take sufficient measure to minimize the density of refrigerant.
6. Never touch the refrigerant piping or compressor without wearing glove to avoid scald or frostbite.

Improper installation may lead to fire hazard, explosion, electric shock or injury.

7. Notes for Installation and Maintenance

Safety Precautions for Installing and Relocating the Unit:

To ensure safety, please be mindful of the following precautions.

WARNINGS

1. When installing or relocating the unit, be sure to keep the refrigerant circuit free from air or substances other than the specified refrigerant.

Any presence of air or other foreign substance in the refrigerant circuit will cause system pressure rise or compressor rupture, resulting in injury.

2. When installing or moving this unit, do not charge the refrigerant which is not comply with that on the nameplate or unqualified refrigerant.

Otherwise, it may cause abnormal operation, wrong action, mechanical malfunction or even serious safety accident.

3. When refrigerant needs to be recovered during relocating or repairing the unit, be sure that the unit is running in cooling mode. Then, fully close the valve at high pressure side (liquid valve). About 30-40 seconds later, fully close the valve at low pressure side (gas valve), immediately stop the unit and disconnect power. Please note that the time for refrigerant recovery should not exceed 1 minute.

If refrigerant recovery takes too much time, air may be sucked in and cause pressure rise or compressor rupture, resulting in injury.

4. During refrigerant recovery, make sure that liquid valve and gas valve are fully closed and power is disconnected before detaching the connection pipe.

If compressor starts running when stop valve is open and connection pipe is not yet connected, air will be sucked in and cause pressure rise or compressor rupture, resulting in injury.

5. When installing the unit, make sure that connection pipe is securely connected before the compressor starts running.

If compressor starts running when stop valve is open and connection pipe is not yet connected, air will be sucked in and cause pressure rise or compressor rupture, resulting in injury.

6. Prohibit installing the unit at the place where there may be leaked corrosive gas or flammable gas.

If there leaked gas around the unit, it may cause explosion and other accidents.

7. Do not use extension cords for electrical connections. If the electric wire is not long enough, please contact a local service center authorized and ask for a proper electric wire.

Poor connections may lead to electric shock or fire

8. Use the specified types of wires for electrical connections between the indoor and outdoor units. Firmly clamp the wires so that their terminals receive no external stresses.

Electric wires with insufficient capacity, wrong wire connections and insecure wire terminals may cause electric shock or fire

7. Notes for Installation and Maintenance

Main Tools for Installation and Maintenance



Level meter



Measuring tape



Screw driver



Impact drill



Drill head



Electric drill



Electroprobe



Universal meter



Torque wrench



Open-end wrench



Inner hexagon spanner



Electronic leakage detector



Vacuum pump



Pressure meter



Pipe pliers



Pipe pliers



Pipe cutter



Pipe expander



Pipe bender



Soldering appliance



Refrigerant container



Electronic scale

8. Installation

8.1 Installation Dimension Diagram

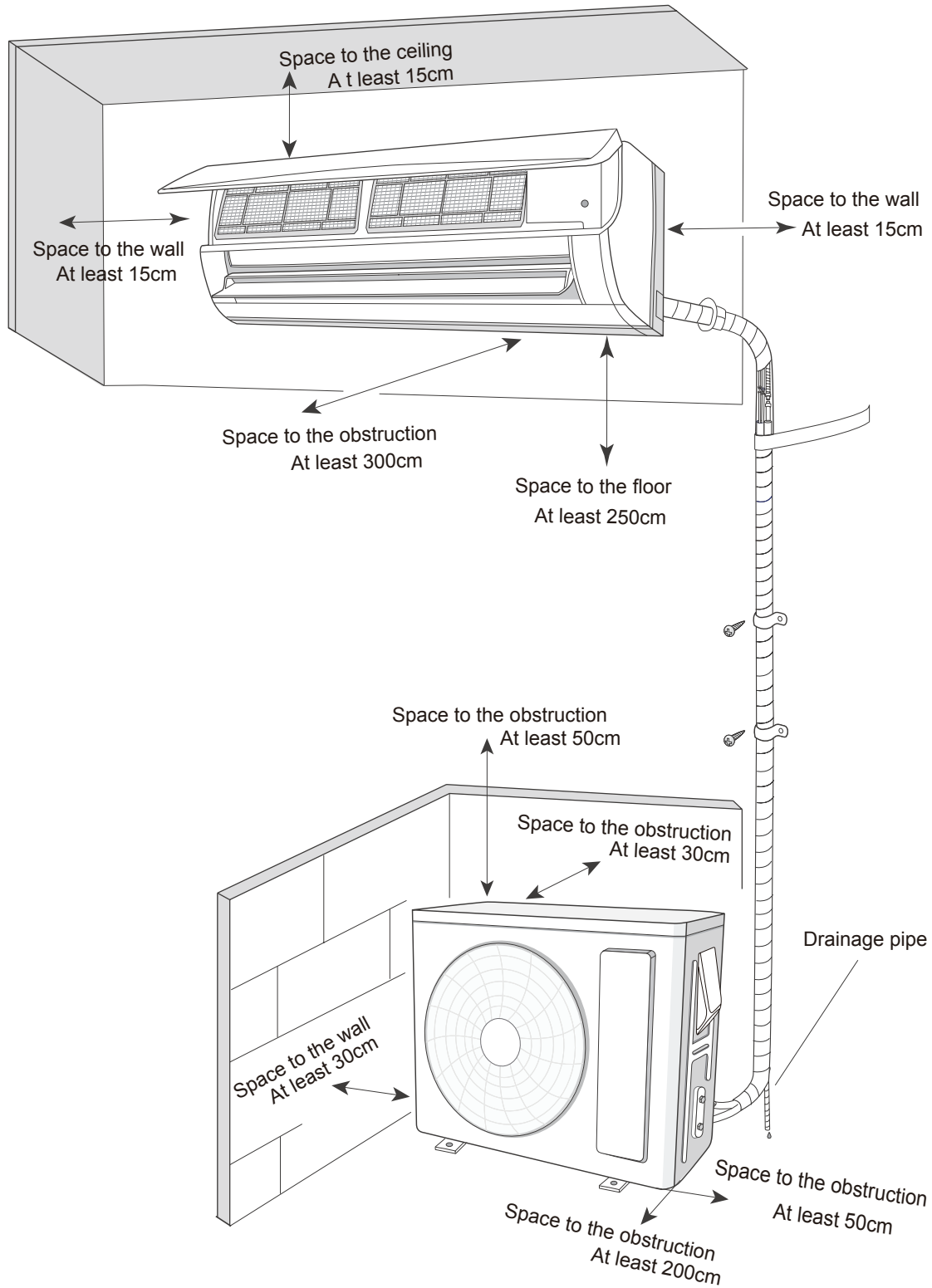

8. Installation

Installation Procedures

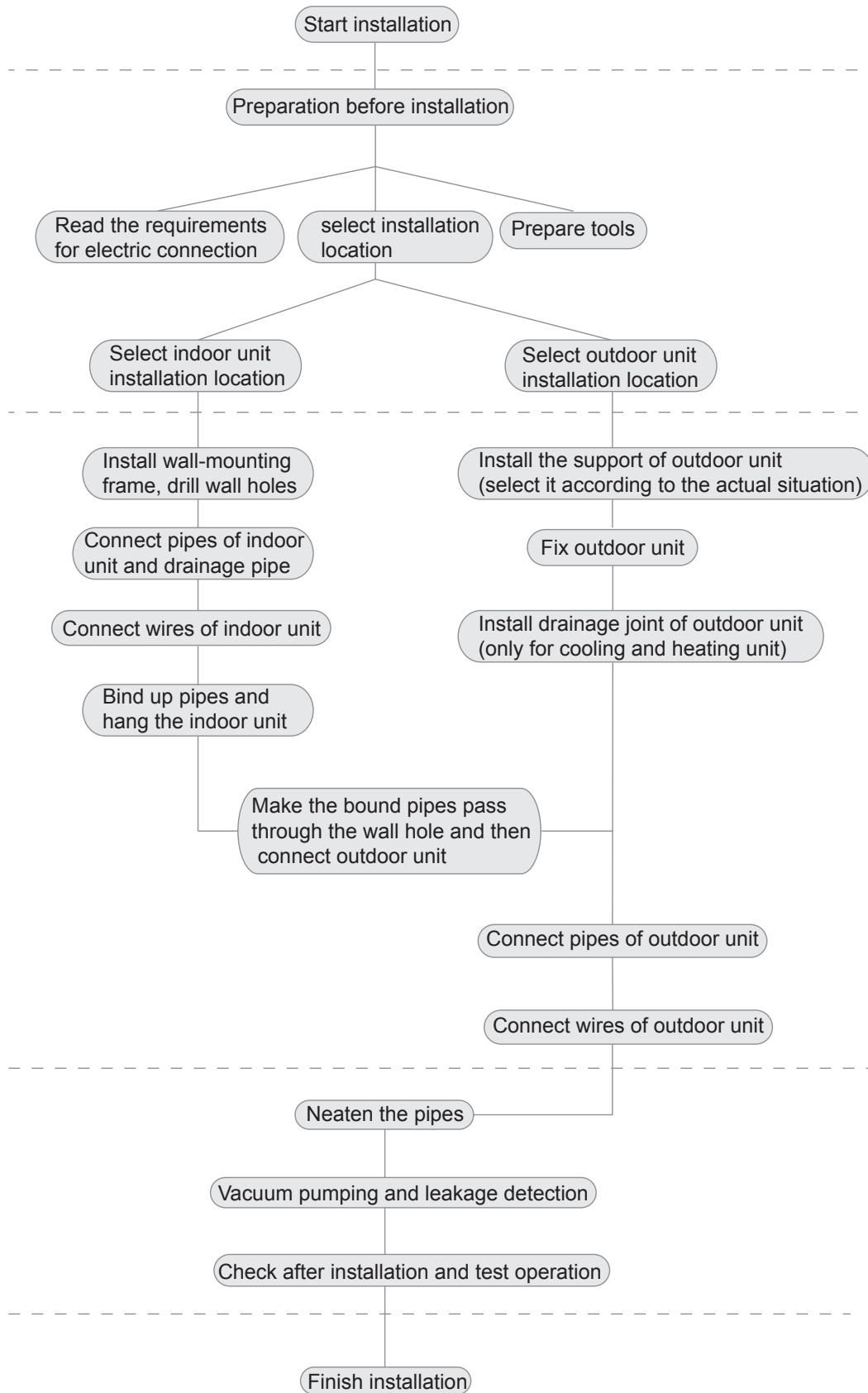

Note: this flow is only for reference; please find the more detailed installation steps in this section.

8. Installation

8.2 Installation Parts-checking

No.	Name
1	Indoor unit
2	Outdoor unit
3	Connection pipe
4	Drainage pipe
5	Wall-mounting frame
6	Connecting cable(power cord)
7	Wall pipe
8	Sealing gum
9	Wrapping tape
10	Support of outdoor unit
11	Fixing screw
12	Drainage plug(cooling and heating unit)
13	Owners manual, remote controller

⚠ Note:

- 1.Please contact the local agent for installation.
- 2.Don't use unqualified power cord

8.3 Selection of Installation Location

1. Basic Requirement:

Installing the unit in the following places may cause malfunction. If it is unavoidable, please consult the local dealer:

- (1) The place with strong heat sources, vapors, flammable or explosive gas, or volatile objects spread in the air.
- (2) The place with high-frequency devices (such as welding machine, medical equipment).
- (3) The place near coast area.
- (4) The place with oil or fumes in the air.
- (5) The place with sulfureted gas.
- (6) Other places with special circumstances.
- (7) The appliance shall not be installed in the laundry.
- (8) It's not allowed to be installed on the unstable or motive base structure (such as truck) or in the corrosive environment (such as chemical factory).

2. Indoor Unit:

- (1) There should be no obstruction near air inlet and air outlet.
- (2) Select a location where the condensation water can be dispersed easily and won't affect other people.
- (3) Select a location which is convenient to connect the outdoor unit and near the power socket.
- (4) Select a location which is out of reach for children.
- (5) The location should be able to withstand the weight of indoor unit and won't increase noise and vibration.
- (6) The appliance must be installed 2.5m above floor
- (7) Don't install the indoor unit right above the electric appliance.
- (8) Please try your best to keep way from fluorescent lamp

3. Outdoor Unit:

- (1) Select a location where the noise and outflow air emitted by the outdoor unit will not affect neighborhood.
- (2) The location should be well ventilated and dry, in which the outdoor unit won't be exposed directly to sunlight or strong wind.
- (3) The location should be able to withstand the weight of outdoor

unit.

(4) Make sure that the installation follows the requirement of installation dimension diagram.

(5) Select a location which is out of reach for children and far away from animals or plants.If it is unavoidable, please add fence for safety purpose.

8.4 Electric Connection Requirement

1. Safety Precaution

(1) Must follow the electric safety regulations when installing the unit.

(2) According to the local safety regulations, use qualified power supply circuit and air switch.

(3) Make sure the power supply matches with the requirement of air conditioner. Unstable power supply or incorrect wiring may result in electric shock, fire hazard or malfunction. Please install proper power supply cables before using the air conditioner.

(4) Properly connect the live wire, neutral wire and grounding wire of power socket.

(5) Be sure to cut off the power supply before proceeding any work related to electricity and safety.

(6) Do not put through the power before finishing installation

(7) The temperature of refrigerant circuit will be high, please keep the interconnection cable away from the copper tube.

(8) The appliance shall be installed in accordance with national wiring regulations.

2. Grounding Requirement:

(1) The air conditioner is I class electric appliance. It must be properly grounding with specialized grounding device by a professional. Please make sure it is always grounded effectively, otherwise it may cause electric shock.

(2) The yellow-green wire in air conditioner is grounding wire, which can't be used for other purposes.

(3) The grounding resistance should comply with national electric safety regulations.

(4) The appliance must be positioned so that the plug is accessible.

(5) An all-pole disconnection switch having a contact separation of at least 3mm in all poles should be connected in fixed wiring

(6) Including an air switch with suitable capacity, please note the following table. Air switch should be included magnet buckle and heating buckle function, it can protect the circuit-short and overload. (Caution: please do not use the fuse only for protect the circuit)

8.5 Installation of Indoor Unit

1. Choosing Installation location

Recommend the installation location to the client and then confirm it with the client

2. Install Wall-mounting Frame

(1) Hang the wall-mounting frame on the wall; adjust it in horizontal position with the level meter and then point out the screw fixing holes on the wall

(2) Drill the screw fixing holes on the wall with impact drill (the specification of drill head should be the same as the plastic expansion particle) and then fill the plastic expansion particles in

8. Installation

the holes.

(3) Fix the wall-mounting frame on the wall with tapping screws and then check if the frame is firmly installed by pulling the frame. If the plastic expansion particle is loose, please drill another fixing hole nearby.

3. Install Wall-mounting Frame

(1) Choose the position of piping hole according to the direction of outlet pipe. The position of piping hole should be a little lower than the wall-mounted frame. (As show in Fig.1)

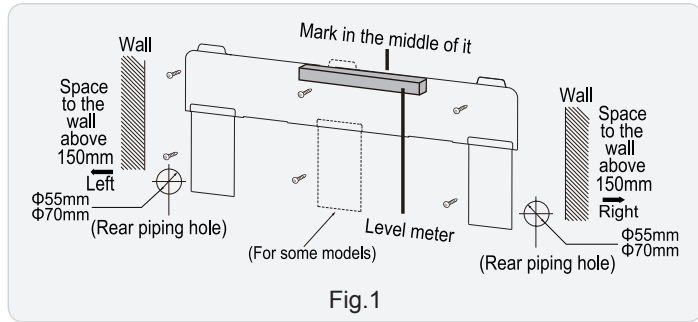

(2) Open a piping hole with the diameter of $\Phi 2 \frac{3}{4}$ " on the selected outlet pipe position. In order to drain smoothly, slant the piping hole on the wall slightly downward to the outdoor side with the gradient of 5-10°. (As show in Fig.2)

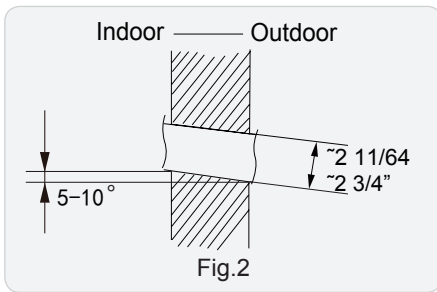

⚠ Note:

Pay attention to dust prevention and take relevant safety measures when opening the hole.

4. Outlet Pipe

(1) The pipe can be led out in the direction of right, rear right, left or rear left. (As show in Fig.3)

(2) When selecting leading out the pipe from left or right, please cut off the corresponding hole on the bottom case. (As show in Fig.4)

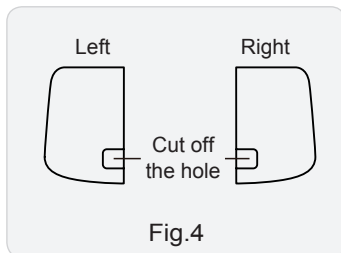
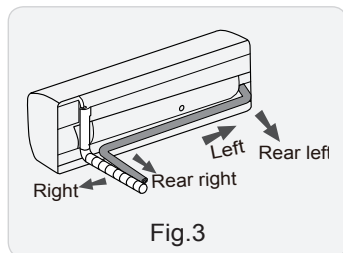

5. Connect the Pipe of Indoor Unit

(1) Aim the pipe joint at the corresponding bellmouth. (As show in Fig.5)

(2) Pretightening the union nut with hand.

(3) Adjust the torque force by referring to the following sheet. Place the open-end wrench on the pipe joint and place the

torque wrench on the union nut. Tighten the union nut with torque wrench. (As show in Fig.6)

(4) Wrap the indoor pipe and joint of connection pipe with insulating pipe, and then wrap it with tape. (As show in Fig.7)

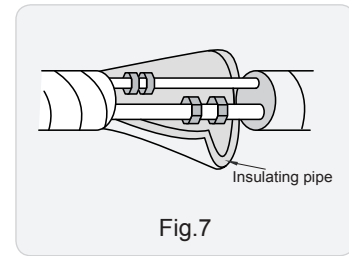
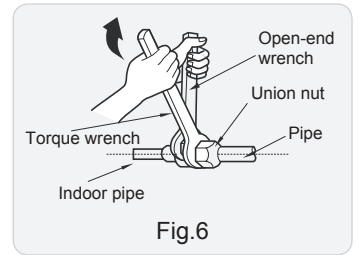
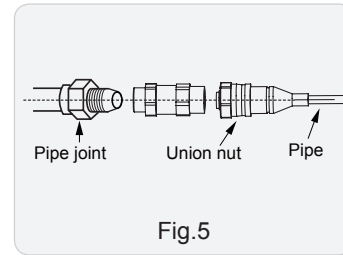

Refer to the following table for wrench moment of force:

Piping size (inch)	Tightening torque (N·m)
1/4	15~20
3/8	30~40
1/2	45~55
5/8	60~65
3/4	70~75

6. Install Drain Hose

(1) Connect the drain hose to the outlet pipe of indoor unit. (As show in Fig.8)

(2) Bind the joint with tape. (As show in Fig.9)

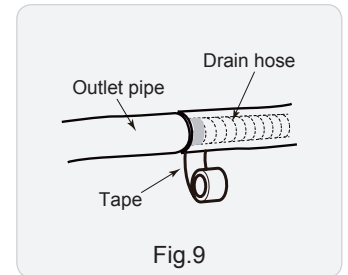
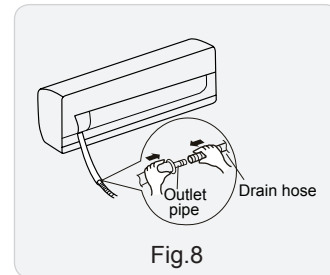

⚠ Note:

(1) Add insulating pipe in the indoor drain hose in order to prevent condensation.

(2) The plastic expansion particles are not provided. (As show in Fig.10)

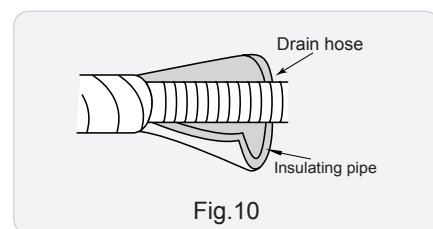

8. Installation

7. Connect Wire of Indoor Unit

(1) Open the panel, remove the screw on the wiring cover and then take down the cover. (As show in Fig.11)

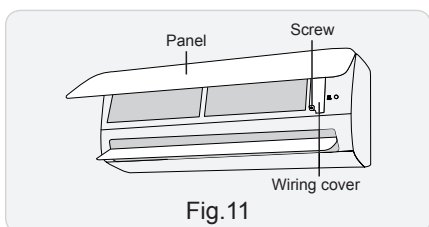

Fig.11

(2) Make the power connection wire go through the cable-cross hole at the back of indoor unit and then pull it out from the front side. (As show in Fig.12)

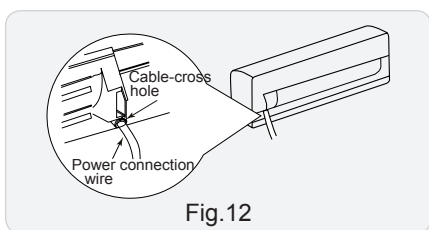

Fig.12

(3) Remove the wire clip; connect the power connection wiresignal control wire (only for cooling and heating unit) to the wiring terminal according to the color; tighten the screw and then fix the power connection wire with wire clip. (As show in Fig.13)

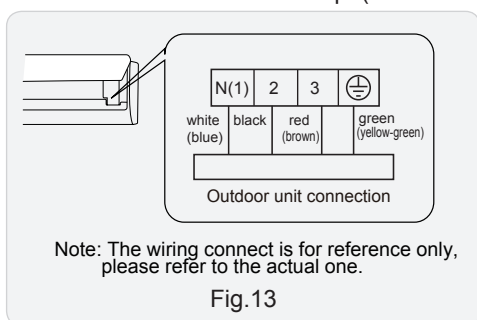

Fig.13

(4) Put wiring cover back and then tighten the screw.
(5) Close the panel.

⚠ Note:

- (1) All wires of indoor unit and outdoor unit should be connected by a professional.
- (2) If the length of power connection wire is insufficient, please contact the supplier for a new one. Avoid extending the wire by yourself.
- (3) For the air conditioner with plug, the plug should be reachable after finishing installation
- (4) For the air conditioner without plug, an air switch must be installed in the line. The air switch should be all-pole parting and the contact parting distance should be more than 3mm.

8. Bind up Pipe

- (1) Bind up the connection pipe, power cord and drain hose with the band. (As show in Fig.14)
- (2) Reserve a certain length of drain hose and power cord for installation when binding them. When binding to a certain degree, separate the indoor power and then separate the drain hose. (As show in Fig.15)
- (3) Bind them evenly.
- (4) The liquid pipe and gas pipe should be bound separately at the end.

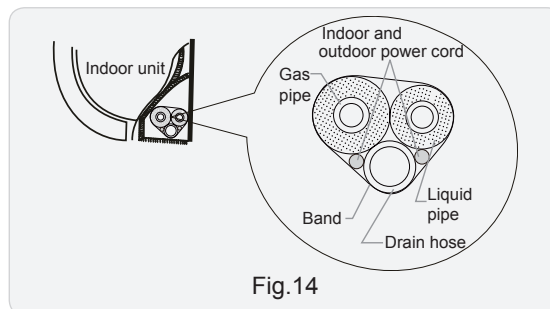

Fig.14

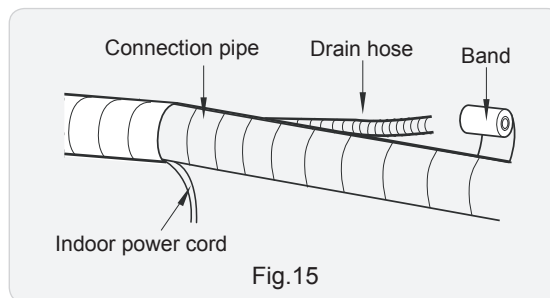

Fig.15

⚠ Note:

- (1) The power cord and control wire can't be crossed or winding.
- (2) The drain hose should be bound at the bottom.

9. Hang the Indoor Unit

- (1) Put the bound pipes in the wall pipe and then make them pass through the wall hole.
- (2) Hang the indoor unit on the wall-mounting frame.
- (3) Stuff the gap between pipes and wall hole with sealing gum.
- (4) Fix the wall pipe. (As show in Fig.16)
- (5) Check if the indoor unit is installed firmly and closed to the wall. (As show in Fig.17)

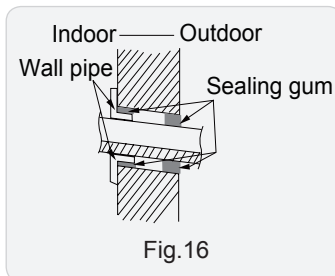

Fig.16

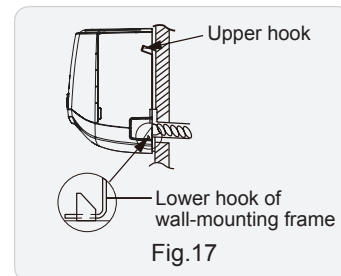

Fig.17

⚠ Note:

Do not bend the drain hose too excessively in order to prevent blocking.

8.6 Installation of Outdoor unit

1. Fix the Support of Outdoor Unit(Select it according to the actual installation situation)

- (1) Select installation location according to the house structure.
- (2) Fix the support of outdoor unit on the selected location with expansion screws.

⚠ Note:

- (1) Take sufficient protective measures when installing the outdoor unit.
- (2) Make sure the support can withstand at least four times the unit weight.
- (3) The outdoor unit should be installed at least 3cm above the floor in order to install drain joint.(As show in Fig.18)

8. Installation

(4) For the unit with cooling capacity of 2300W~5000W, 6 expansion screws are needed; for the unit with cooling capacity of 6000W~8000W, 8 expansion screws are needed; for the unit with cooling capacity of 10000W~16000W, 10 expansion screws are needed.

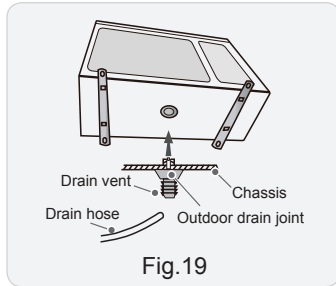
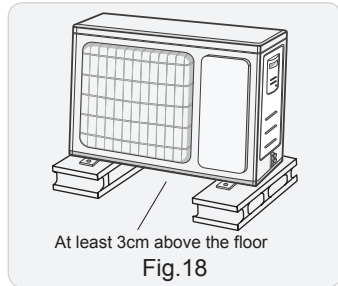

2. Install Drain Joint(Only for cooling and heating unit)

- (1) Connect the outdoor drain joint into the hole on the chassis.
- (2) Connect the drain hose into the drain vent.(As show in Fig.19)

3. Fix Outdoor Unit

- (1) Place the outdoor unit on the support.
- (2) Fix the foot holes of outdoor unit with bolts.(As show in Fig.20)

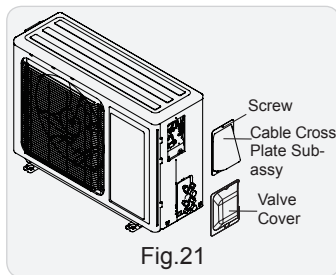
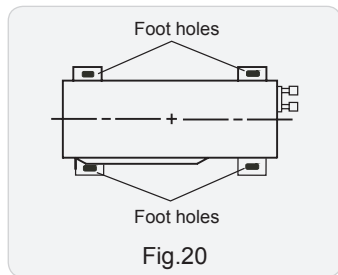

4. Connect Indoor and Outdoor Pipes

- (1) Remove the screw on the right handle of outdoor unit and then remove the handle. (As show in Fig.21)
- (2) Remove the big hanging ring.
- (3) Remove the protective rubber plug of the valve.

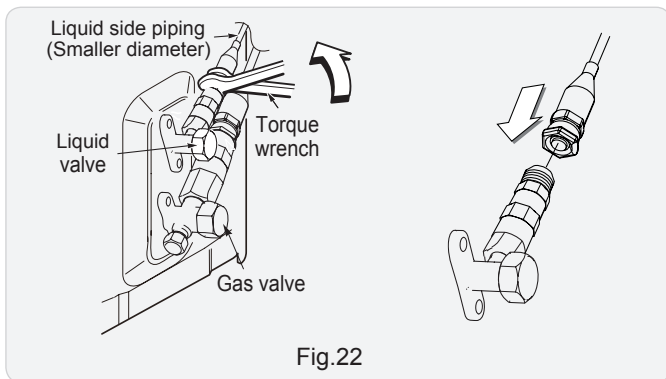

- (4) Adjust the connecting pipe. Connect the female connector of the pipe to the male connector of the unit. (Note: connect the small pipe first)

Refer to the following table for wrench moment of force :

Piping size (inch)	Tightening torque (N.m)
1/4	15~20
3/8	30~40
1/2	45~55
5/8	60~65
3/4	70~75

5. Connect Outdoor Electric Wire

- (1) Remove the wire clip; connect the power connection wire and signal control wire (only for cooling and heating unit) to the wiring terminal according to the color; fix them with screws. (As show in Fig.23)

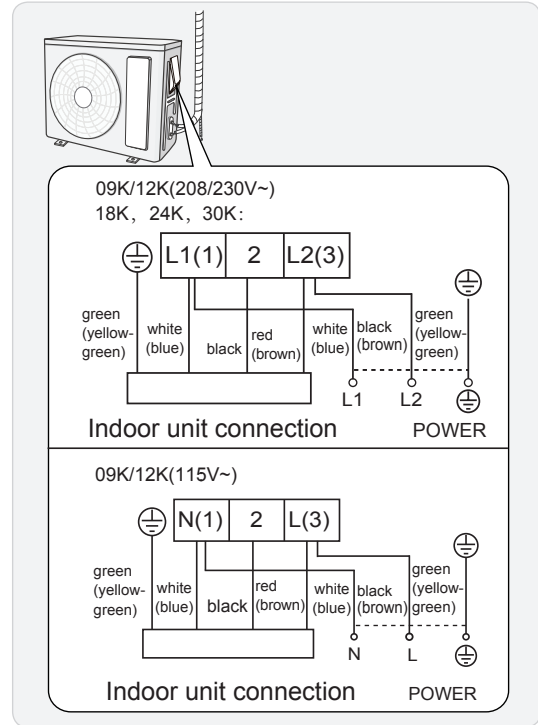

Note: the wiring connect is for reference only, please refer to the actual one.

⚠ Note:

- (1) After tightening the screw, pull the power cord slightly to check if it is firm
- (2) Never cut the power connection wire to prolong or shorten the distance.
- (3) The connecting wire and connection pipe cannot touch each other.
- (4) Top cover of outdoor unit and electric box assembly should be fixed by the screw. Otherwise, it can cause a fire, or short circuit caused by water or dust.

Install the over line pipe

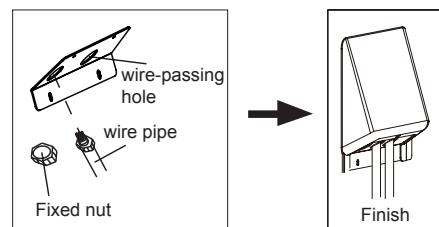

6. Neaten the Pipes

- (1) The pipes should be placed along the wall, bent reasonably and hidden possibly. Min. semidiameter of bending the pipe is 10cm.
- (2) If the outdoor unit is higher than the wall hole, you must set a U-shaped curve in the pipe before pipe goes into the room, in order to prevent rain from getting into the room. (As show in Fig.24)

8. Installation

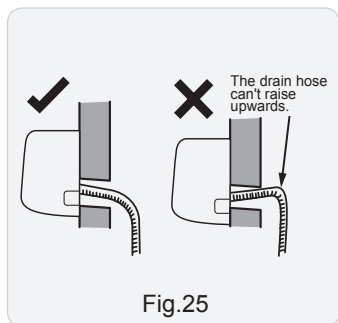
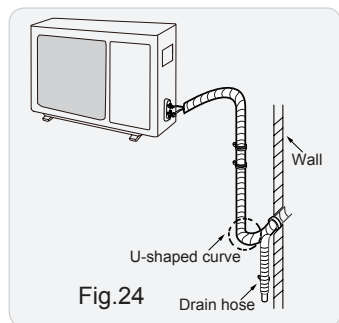

⚠ Note:
 (1) The through-wall height of drain hose shouldn't be higher than the outlet pipe hole of indoor unit.(As show in Fig.25)
 (2) Slant the drain hose slightly downwards. The drain hose can't be curved, raised and fluctuant, etc.(As show in Fig.26)
 (3) The water outlet can't be placed in water in order to drain smoothly.(As show in Fig.27)

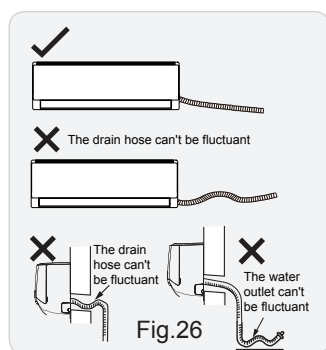

8.7 Test and operation

Use vacuum pump

- 1.Remove the valve caps on the liquid valve and gas valve and the nut of refrigerant charging vent.
2. Connect the charging hose of piezometer to the refrigerant charging vent of gas valve and then connect the other charging hose to the vacuum pump.
3. Open the piezometer completely and operate for 10-15min to check if the pressure of piezometer remains in -0.1MPa.
4. Close the vacuum pump and maintain this status for 1-2min to check if the pressure of piezometer remains in -0.1MPa. If the pressure decreases, there may be leakage.
5. Remove the piezometer, open the valve core of liquid valve and gas valve completely with inner hexagon spanner.
6. Tighten the screw caps of valves and refrigerant charging vent.
7. Reinstall the handle.

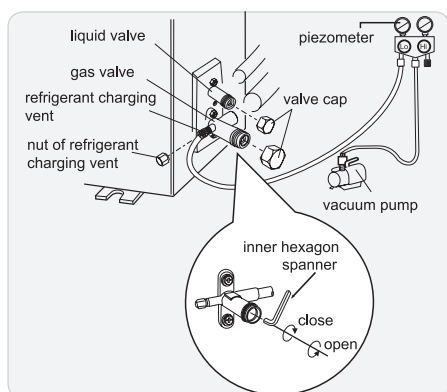

8.8 Leakage Detection

- (1) With leakage detector:
Check if there is leakage with leakage detector.
- (2) With soap water:
If leakage detector is not available, please use soap water for leakage detection. Apply soap water at the suspected position and keep the soap water for more than 3min. If there are air bubbles coming out of this position, There's a leakage.

8.9 Check after Installation and Test operation

1. Check after Installation

Check according to the following requirement after finishing installation.

NO.	Items to be checked	Possible malfunction
1	Has the unit been installed firmly	The unit may drop, shake or emit noise.
2	Have you done the refrigerant leakage test?	It may cause insufficient cooling (heating) capacity.
3	Is heat insulation of pipeline sufficient	It may cause condensation and water dripping.
4	Is water drained well?	It may cause condensation and water dripping.
5	Is the voltage of power supply according to the voltage marked on the nameplate?	It may cause malfunction or damage the parts.
6	Is electric wiring and pipeline installed correctly?	It may cause malfunction or damage the parts.
7	Is the unit grounded securely?	It may cause electric leakage.
8	Does the power cord follow the specification	It may cause malfunction or damage the parts.
9	Is there any obstruction in air inlet and air outlet?	It may cause insufficient cooling (heating) capacity.
10	The dust and sundries caused during installation are removed?	It may cause malfunction or damaging the parts.
11	The gas valve and liquid valve of connection pipe are open completely?	It may cause insufficient cooling (heating) capacity.
12	Is the inlet and outlet of piping hole been covered?	It may cause insufficient cooling(heating) capacity or waster eletricity.

2. Test Operation

- (1) Preparation of test operation
 - The client approves the air conditioner installation.
 - Specify the important notes for air conditioner to the client.
- (2) Method of test operation
 - Put through the power, press ON/OFF button on the remote controller to start operation.
 - Press MODE button to select AUTO, COOL, DRY, FAN and HEAT to check whether the operation is normal or not.
 - If the ambient temperature is lower than 16°C , the air conditioner can't start cooling.

9. Maintenance

9.1 Error Code List

No.	Malfunction Name	Display Method of Indoor Unit	A/C status	Possible Causes
		Dual-8 Code Display		
1	High pressure protection of system	E1	During cooling and drying operation, except indoor fan operates, all loads stop operation. During heating operation, the complete unit stops.	Possible reasons: 1. Refrigerant was superabundant; 2. Poor heat exchange (including filth blockage of heat exchanger and bad radiating environment); Ambient temperature is too high.
2	Low pressure protection of system	E3	The Dual-8 Code Display will show E3 until the low pressure switch stop operation.	1.Low-pressure protection 2.Low-pressure protection of system 3.Low-pressure protection of compressor
3	High discharge temperature protection of compressor	E4	During cooling and drying operation, compressor and outdoor fan stop while indoor fan operates. During heating operation, all loads stop.	Please refer to the malfunction analysis (discharge protection, overload).
4	Overcurrent protection	E5	During cooling and drying operation, compressor and outdoor fan stop while indoor fan operates. During heating operation, all loads stop.	1. Supply voltage is unstable; 2. Supply voltage is too low and load is too high; 3. Evaporator is dirty.
5	Communication Malfunction	E6	During cooling operation, compressor stops while indoor fan motor operates. During heating operation, the complete unit stops.	Refer to the corresponding malfunction analysis.
6	High temperature resistant protection	E8	During cooling operation: compressor will stop while indoor fan will operate. During heating operation, the complete unit stops.	Refer to the malfunction analysis (overload, high temperature resistant).
7	EEPROM malfunction	EE	During cooling and drying operation, compressor will stop while indoor fan will operate; During heating operation, the complete unit will stop	Replace outdoor control panel AP1
8	Limit/decrease frequency due to high temperature of module	EU	All loads operate normally, while operation frequency for compressor is decreased	Discharging after the complete unit is de-energized for 20mins, check whether the thermal grease on IPM Module of outdoor control panel AP1 is sufficient and whether the radiator is inserted tightly. If it's no use, please replace control panel AP1.
9	Malfunction protection of jumper cap	C5	Wireless remote receiver and button are effective, but can not dispose the related command	1. No jumper cap insert on mainboard. 2. Incorrect insert of jumper cap. 3. Jumper cap damaged. 4. Abnormal detecting circuit of mainboard.
10	Gathering refrigerant	Fo	When the outdoor unit receive signal of Gathering refrigerant ,the system will be forced to run under cooling mode for gathering refrigerant	Nominal cooling mode
11	Indoor ambient temperature sensor is open/short circuited	F1	During cooling and drying operation, indoor unit operates while other loads will stop; during heating operation, the complete unit will stop operation.	1. Loosening or bad contact of indoor ambient temp. sensor and mainboard terminal. 2. Components in mainboard fell down leads short circuit. 3. Indoor ambient temp. sensor damaged. (check with sensor resistance value chart) 4. Mainboard damaged.

9. Maintenance

No.	Malfunction Name	Display Method of Indoor Unit	A/C status	Possible Causes
		Dual-8 Code Display		
12	Indoor evaporator temperature sensor is open/short circuited	F2	AC stops operation once reaches the setting temperature. Cooling, drying: internal fan motor stops operation while other loads stop operation; heating: AC stop operation	<ol style="list-style-type: none"> 1. Loosening or bad contact of Indoor evaporator temp. sensor and mainboard terminal. 2. Components on the mainboard fall down leads short circuit. 3. Indoor evaporator temp. sensor damaged.(check temp. sensor value chart for testing) 4. Mainboard damaged.
13	Outdoor ambient temperature sensor is open/short circuited	F3	During cooling and drying operating, compressor stops while indoor fan operates; During heating operation, the complete unit will stop operation	Outdoor temperature sensor hasn't been connected well or is damaged. Please check it by referring to the resistance table for temperature sensor)
14	Outdoor condenser temperature sensor is open/short circuited	F4	During cooling and drying operation, compressor stops while indoor fan will operate; During heating operation, the complete unit will stop operation.	Outdoor temperature sensor hasn't been connected well or is damaged. Please check it by referring to the resistance table for temperature sensor)
16	Outdoor discharge temperature sensor is open/short circuited	F5	During cooling and drying operation, compressor will stop after operating for about 3 mins, while indoor fan will operate; During heating operation, the complete unit will stop after operating for about 3 mins.	<ol style="list-style-type: none"> 1.Outdoor temperature sensor hasn't been connected well or is damaged. Please check it by referring to the resistance table for temperature sensor) 2.The head of temperature sensor hasn't been inserted into the copper tube
17	Limit/decrease frequency due to overload	F6	All loads operate normally, while operation frequency for compressor is decreased	Refer to the malfunction analysis (overload, high temperature resistant)
18	Decrease frequency due to overcurrent	F8	All loads operate normally, while operation frequency for compressor is decreased	The input supply voltage is too low; System pressure is too high and overload
19	Decrease frequency due to high air discharge	F9	All loads operate normally, while operation frequency for compressor is decreased	Overload or temperature is too high; Refrigerant is insufficient Malfunction of electric expansion valve (EKV)
20	Limit/decrease frequency due to antifreezing	FH	All loads operate normally, while operation frequency for compressor is decreased	Poor air-return in indoor unit or fan speed is too low
21	Voltage for DC bus-bar is too high	PH	During cooling and drying operation, compressor will stop while indoor fan will operate; During heating operation, the complete unit will stop operation.	<ol style="list-style-type: none"> 1. Measure the voltage of position L and N on wiring board (XT), if the voltage is higher than 265VAC, turn on the unit after the supply voltage is increased to the normal range. 2.If the AC input is normal, measure the voltage of electrolytic capacitor C on control panel (AP1), if it's normal, There's malfunction for the circuit, please replace the control panel (AP1)
22	Voltage of DC bus-bar is too low	PL	During cooling and drying operation, compressor will stop while indoor fan will operate; During heating operation, the complete unit will stop	<ol style="list-style-type: none"> 1. Measure the voltage of position L and N on wiring board (XT), if the voltage is higher than 150VAC, turn on the unit after the supply voltage is increased to the normal range. 2.If the AC input is normal, measure the voltage of electrolytic capacitor C on control panel (AP1), if it's normal, There's malfunction for the circuit, please replace the control panel (AP1)

9. Maintenance

No.	Malfunction Name	Display Method of Indoor Unit	A/C status	Possible Causes
		Dual-8 Code Display		
23	Compressor Min frequency in test state	P0		Showing during min. cooling or min. heating test
24	Compressor rated frequency in test state	P1		Showing during nominal cooling or nominal heating test
25	Compressor maximum frequency in test state	P2		Showing during max. cooling or max. heating test
26	Compressor intermediate frequency in test state	P3		Showing during middle cooling or middle heating test
27	Overcurrent protection of phase current for compressor	P5	During cooling and drying operation, compressor will stop while indoor fan will operate; During heating operation, the complete unit will stop operation.	Refer to the malfunction analysis (IPM protection, loss of synchronism protection and overcurrent protection of phase current for compressor.
28	Charging malfunction of capacitor	PU	During cooling and drying operation, compressor will stop while indoor fan will operate; During heating operation, the complete unit will stop	Refer to the part three—charging malfunction analysis of capacitor
29	Malfunction of module temperature sensor circuit	P7	During cooling and drying operation, compressor will stop while indoor fan will operate; During heating operation, the complete unit will stop	Replace outdoor control panel AP1
30	Module high temperature protection	P8	During cooling operation, compressor will stop while indoor fan will operate; During heating operation, the complete unit will stop	After the complete unit is de-energized for 20mins, check whether the thermal grease on IPM Module of outdoor control panel AP1 is sufficient and whether the radiator is inserted tightly. If it's no use, please replace control panel AP1.
31	Overload protection for compressor	H3	During cooling and drying operation, compressor will stop while indoor fan will operate; During heating operation, the complete unit will stop operation.	1. Wiring terminal OVC-COMP is loosened. In normal state, the resistance for this terminal should be less than 1ohm. 2. Refer to the malfunction analysis (discharge protection, overload)
32	IPM protection	H5	During cooling and drying operation, compressor will stop while indoor fan will operate; During heating operation, the complete unit will stop operation.	Refer to the malfunction analysis (IPM protection, loss of synchronism protection and overcurrent protection of phase current for compressor.
33	Module temperature is too high	P8	During cooling and drying operation, compressor and outdoor fan stop while indoor fan operates. During heating operation, all loads stop.	Radiating grease on IPM module of outdoor unit main board is not enough; screws have not been fixed tightly Hardware malfunction of outdoor unit main board;
34	Internal motor (fan motor) do not operate	H6	Internal fan motor, external fan motor, compressor and electric heater stop operation, guide louver stops at present location.	1. Bad contact of DC motor feedback terminal. 2. Bad contact of DC motor control end. 3. Fan motor is stalling. 4. Motor malfunction. 5. Malfunction of mainboard revdetecting circuit.
35	Desynchro-nizing of compressor	H7	During cooling and drying operation, compressor will stop while indoor fan will operate; During heating operation, the complete unit will stop operation.	Refer to the malfunction analysis (IPM protection, loss of synchronism protection and overcurrent protection of phase current for compressor.

9. Maintenance

2. Malfunction of Blocked Protection of IDU Fan Motor H6

Main detection points:

- SmoothlyIs the control terminal of PG motor connected tightly?
- SmoothlyIs the feedback interface of PG motor connected tightly?
- The fan motor can't operate?
- The motor is broken?
- Detectioncircuit of the mainboard is defined abnormal

Malfunction diagnosis process:

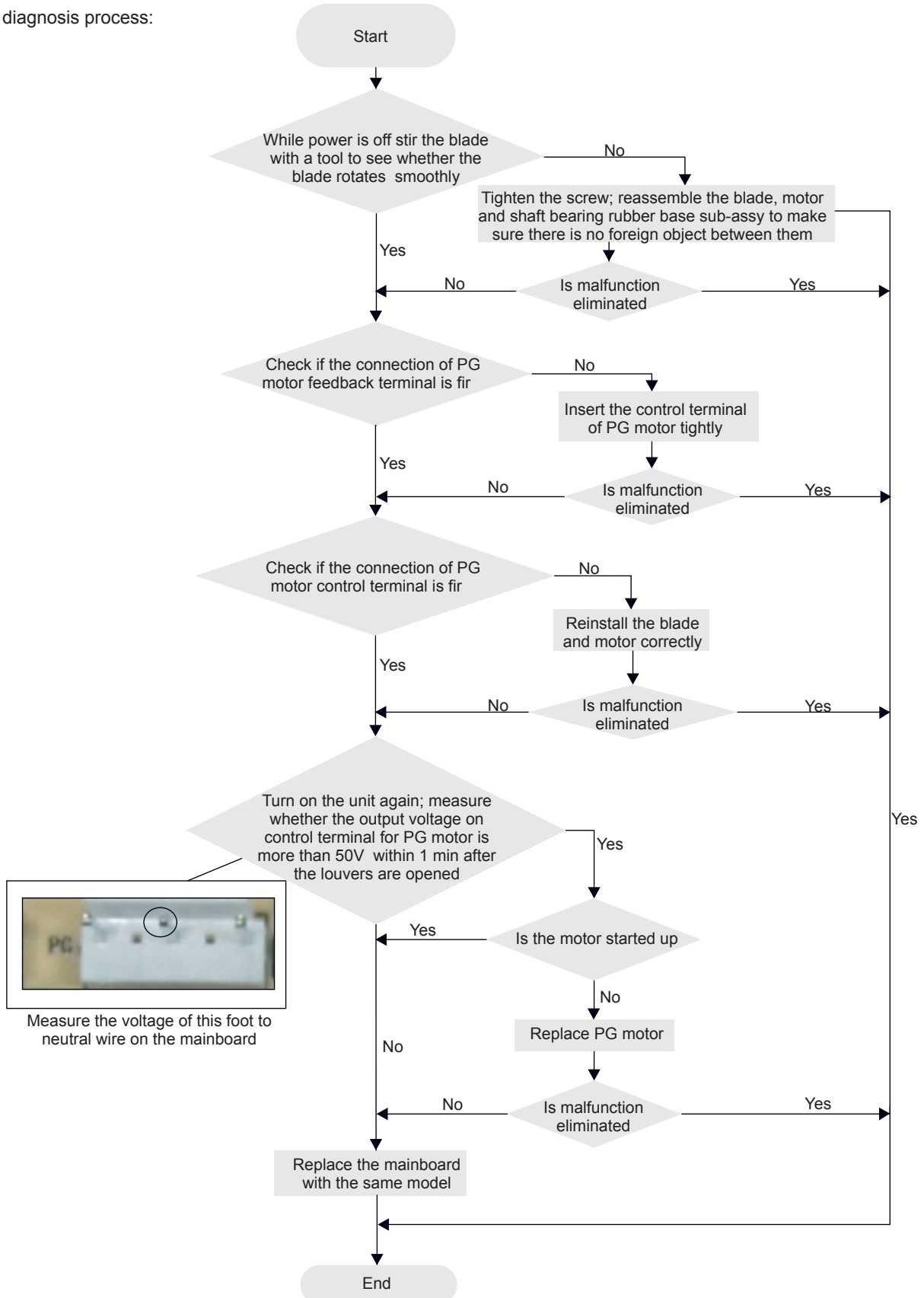

9. Maintenance

3. Malfunction of Protection of Jumper Cap C5

Main detection points:

- Is there jumper cap on the mainboard?
- Is the jumper cap inserted correctly and tightly?
- The jumper is broken?
- The motor is broken?
- Detection circuit of the mainboard is defined abnormal

Malfunction diagnosis process:

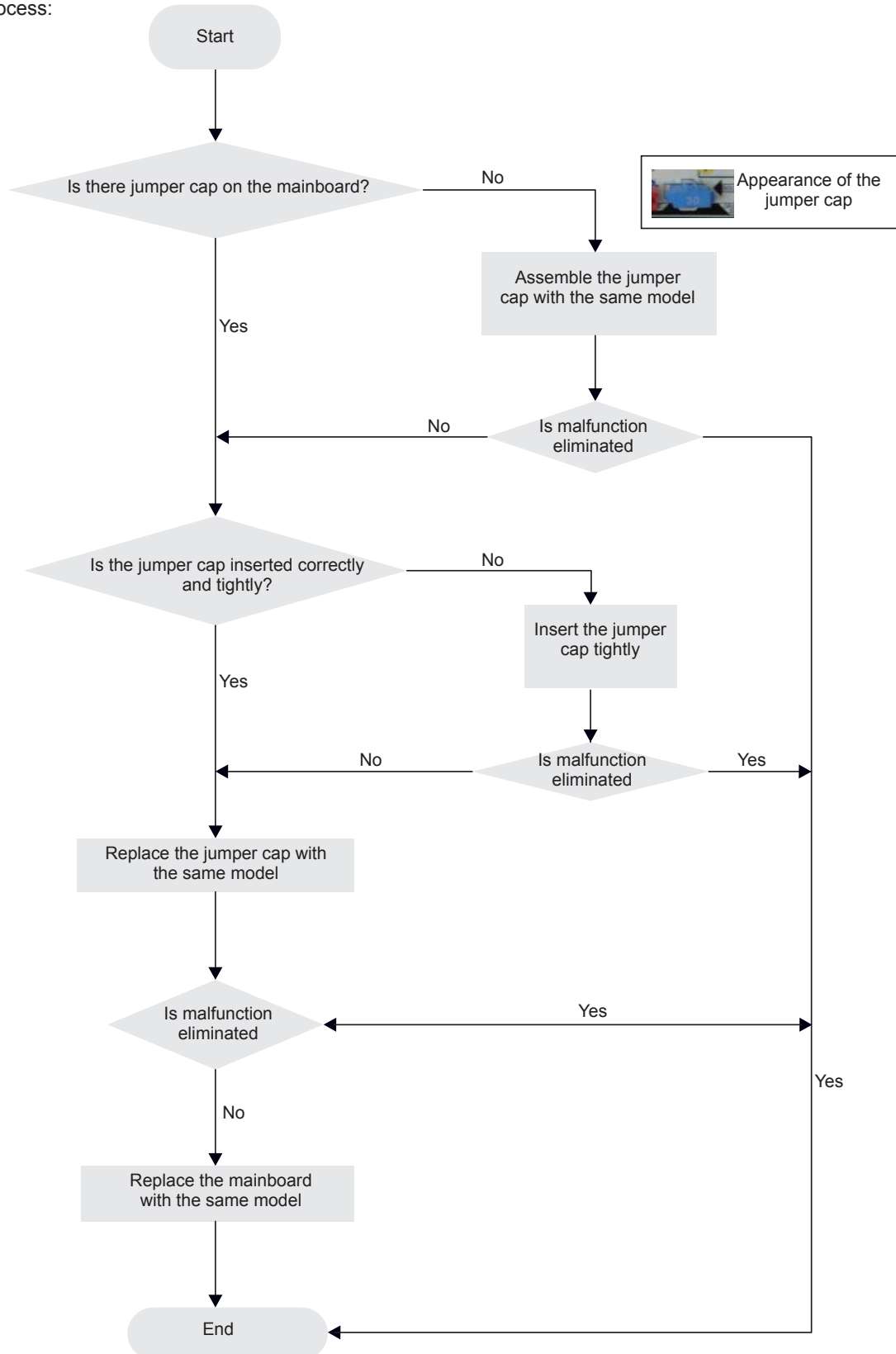

9. Maintenance

4. Malfunction of Zero-crossing Inspection Circuit Malfunction of the IDU Fan Motor U8

Main detection points:

- Instant energization after de-energization while the capacitor discharges slowly?
- The zero-cross detection circuit of the mainboard is defined abnormal

Malfunction diagnosis process:

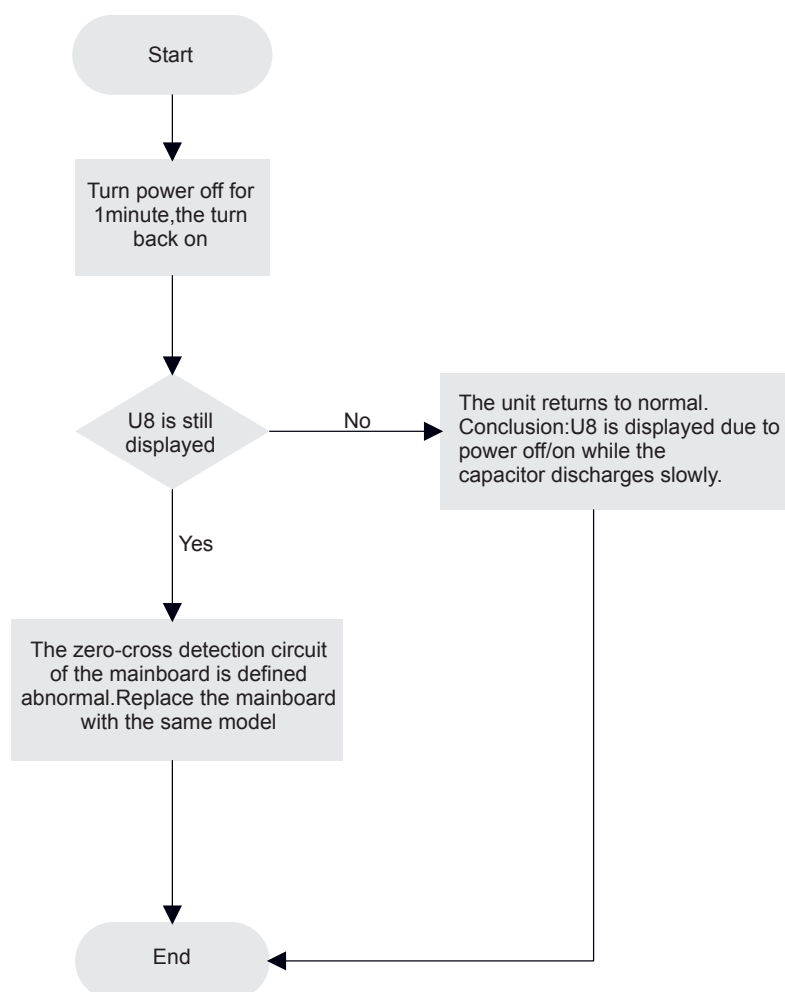

9. Maintenance

5. Malfunction of detecting plate(WIFI) JF

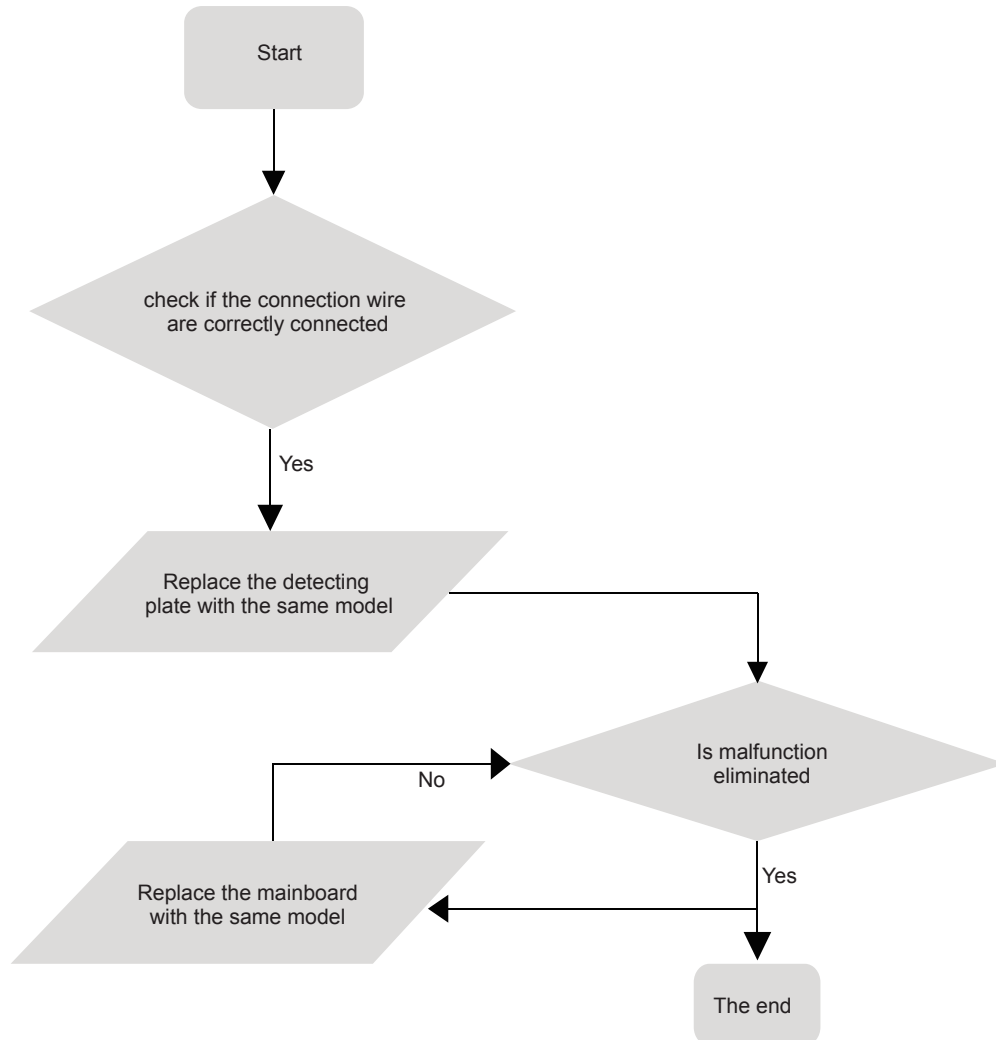

9. Maintenance

6. Malfunction of Insufficient fluorine protection F0

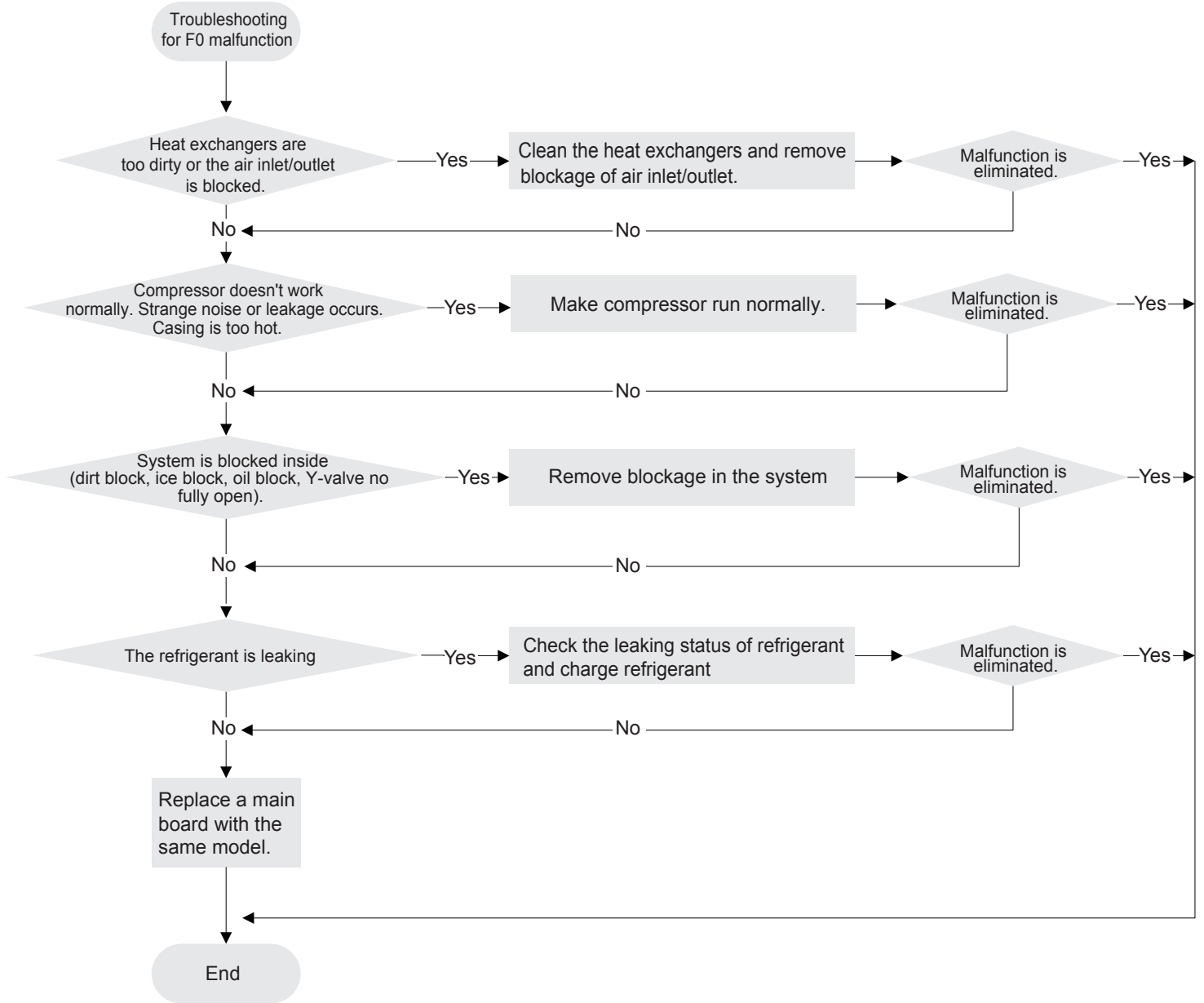

9. Maintenance

7. Communication malfunction E6

Main detection points:

- Check if the connection wire and the built-in wiring of indoor and outdoor unit are connected well and without damage;
- If the communication circuit of indoor mainboard is damaged? If the communication circuit of outdoor mainboard (AP1) is damaged?

Malfunction diagnosis process:

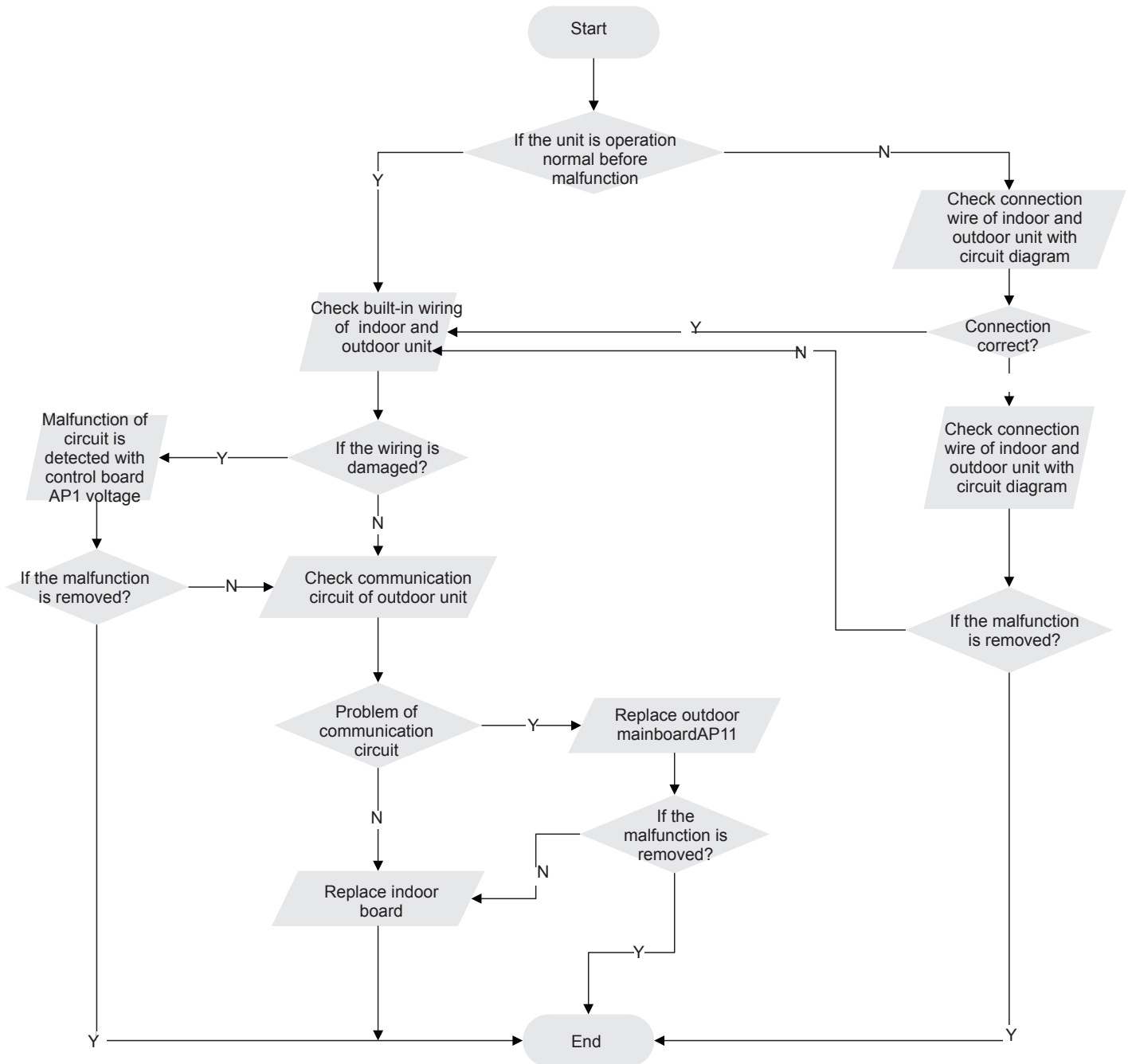

Note: method for checking the communication circuit of outdoor unit: cut off the communication wires of indoor/outdoor unit, and then measure the voltage between COM and N of the control board of outdoor unit (DC notch, about 56V)

9. Maintenance

8. Malfunction of Overcurrent Protection E5

Main detection points:

- Is the supply voltage unstable with big fluctuation
- Is the supply voltage too low with overload?
- Hardware trouble?

Malfunction diagnosis process:

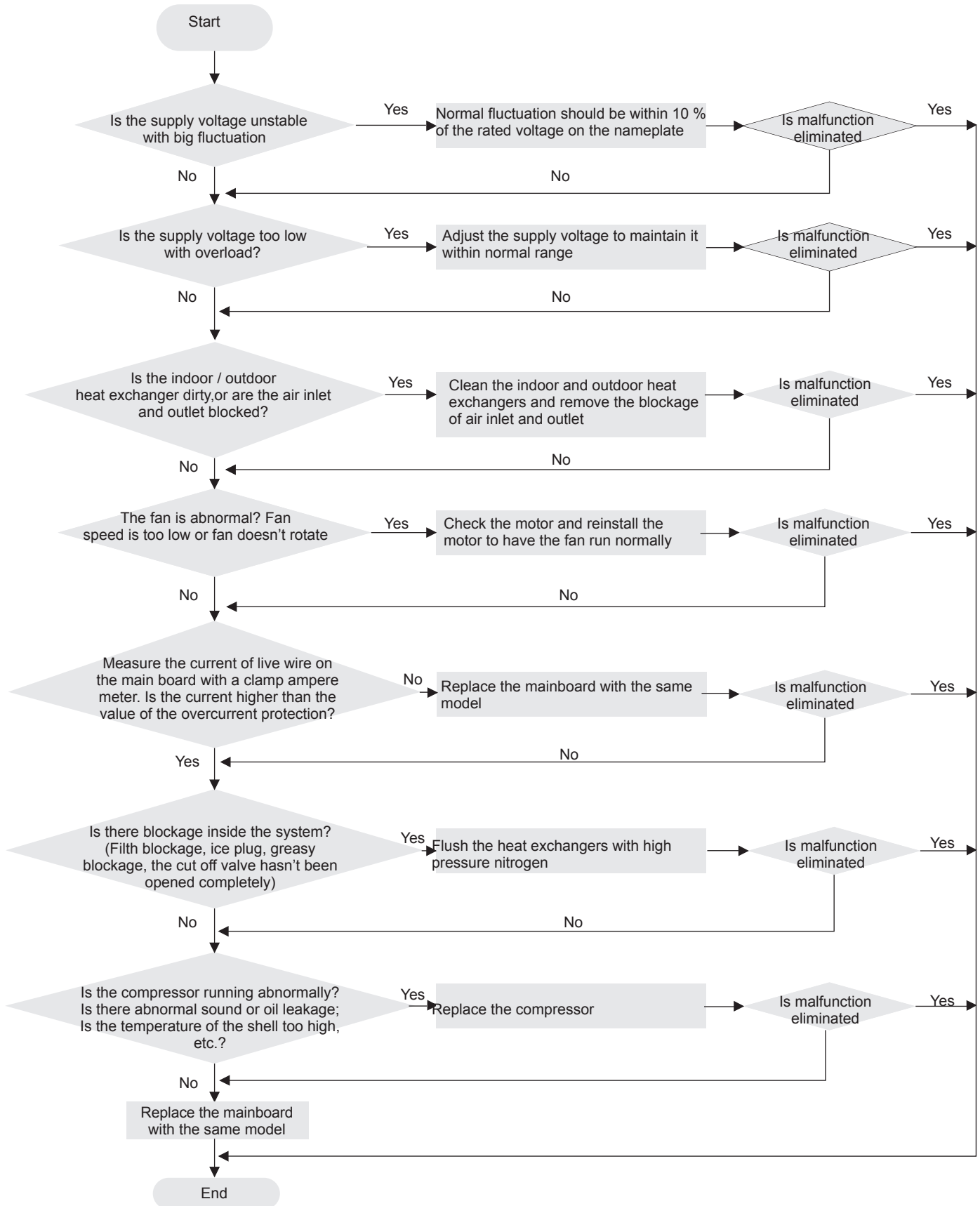

9. Maintenance

●Outdoor unit:

1. Capacitor charge fault (Fault with outdoor unit) (AP1 below refers to the outdoor control panel)

Main Check Points:

- Use AC voltmeter to check if the voltage between terminal L and N on the wiring board is within 210VAC~240VAC.
- Is the reactor (L) correctly connected? Is the connection loose or fallen? Is the reactor (L) damaged?

Fault diagnosis process:

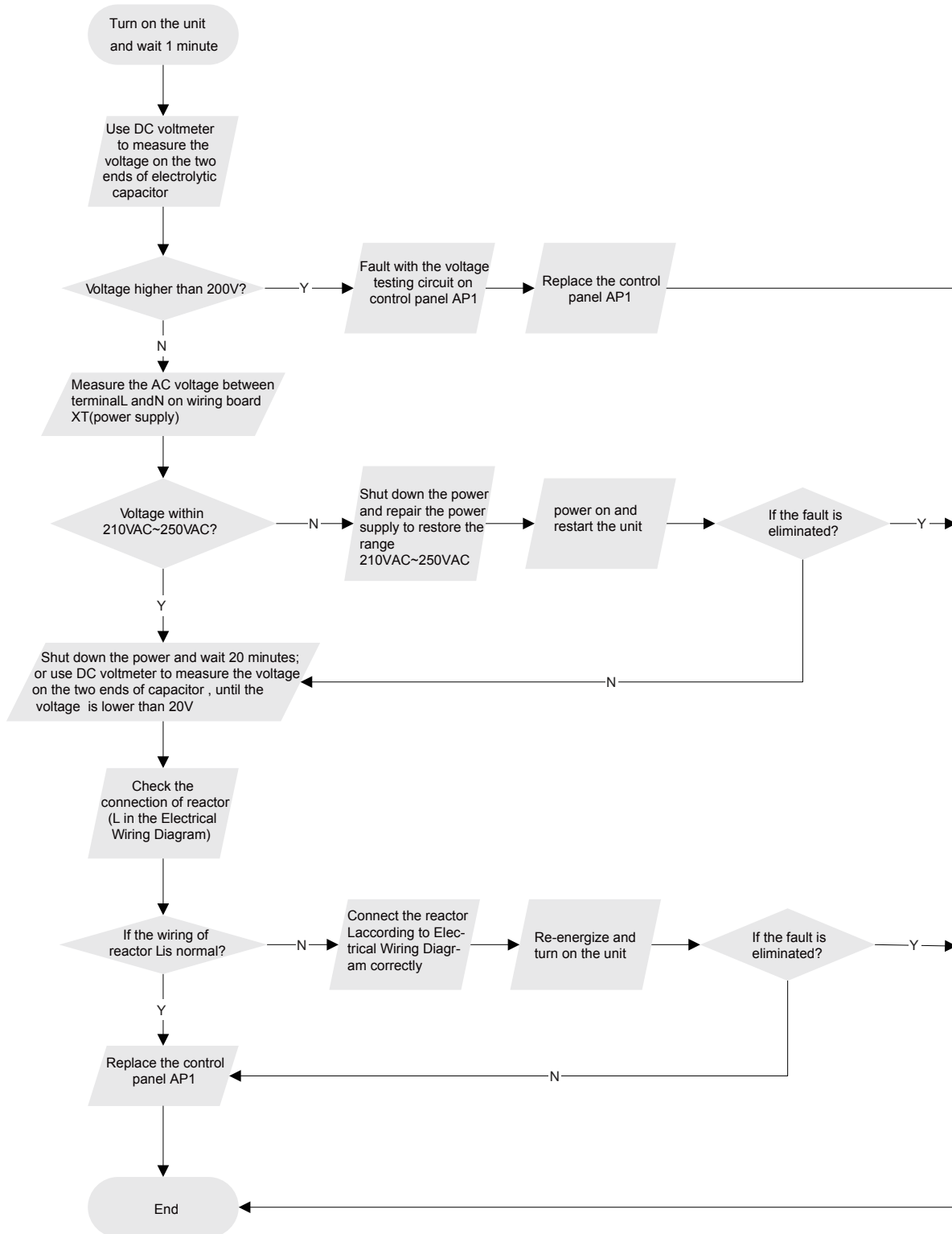

9. Maintenance

2. IPM protection H5 , over-phase current of compressor P5

(AP1 hereinafter refers to the control board of the outdoor unit)

Main detection points:

(1) compressor COMP terminal (2) power supply voltage (3) compressor (4) charging amount of refrigerant (5) air inlet and air outlet of indoor/outdoor unit

Malfunction diagnosis process:

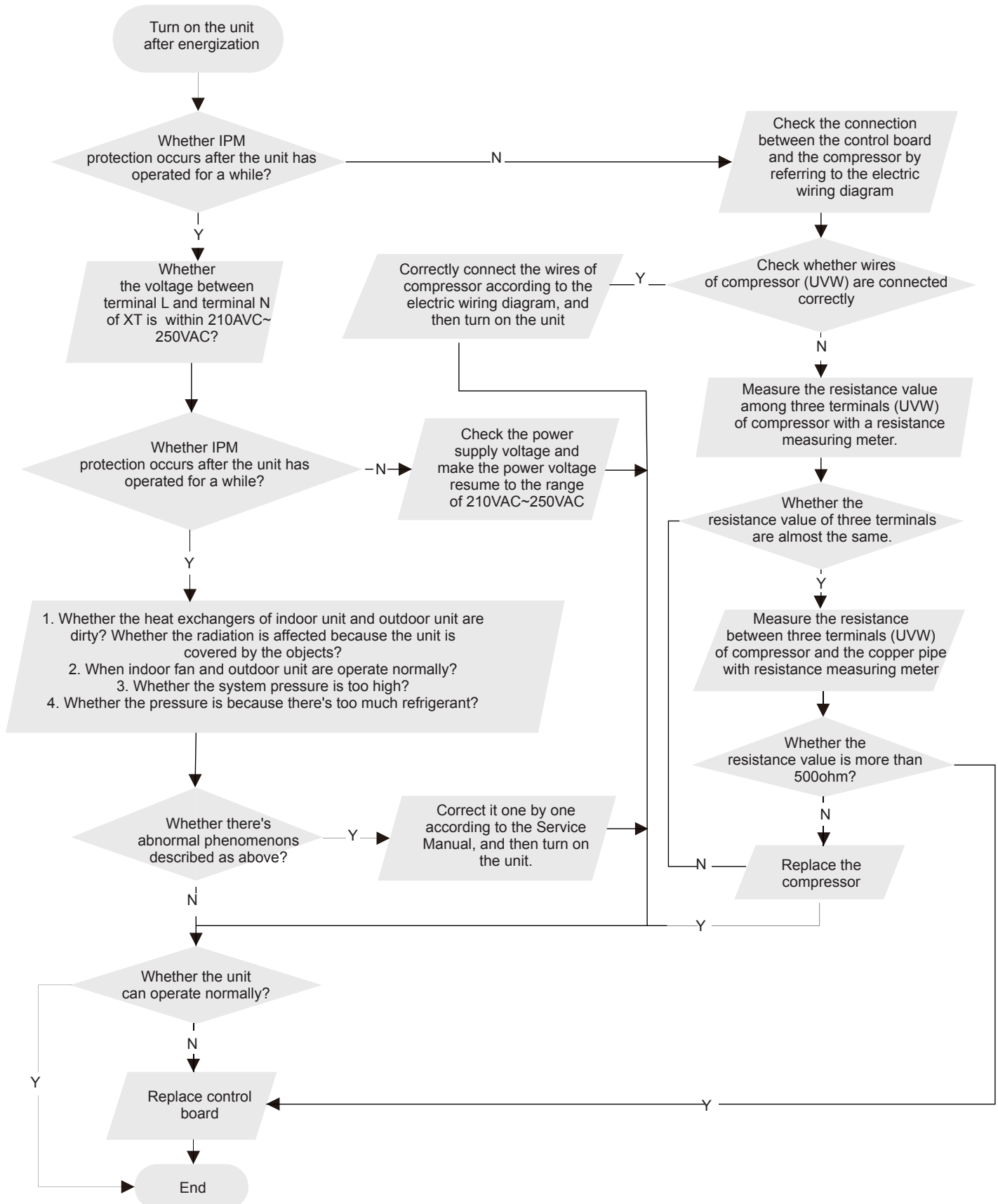

9. Maintenance

3. High temperature and overload protection (E8)(AP1 below means control board of outdoor unit)

Main detection points:

(1) outdoor temperature (2) fan (3)air inlet and air outlet of indoor/outdoor unit

Malfunction diagnosis process:

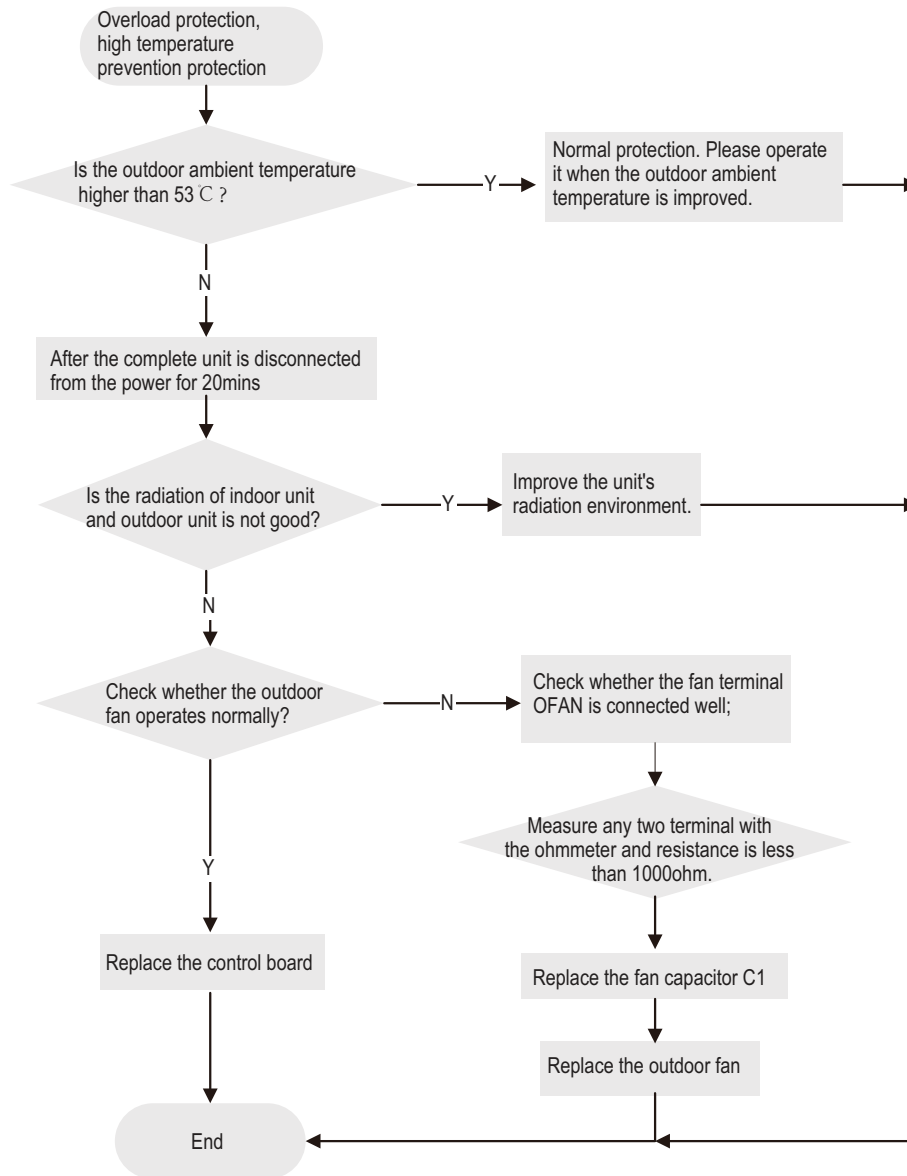

9. Maintenance

4. Start-up failure LC (following AP1 for outdoor unit control board)

Main detection points:

(1) compressor wire (2) compressor (3) charging amount of refrigerant

Malfunction diagnosis process:

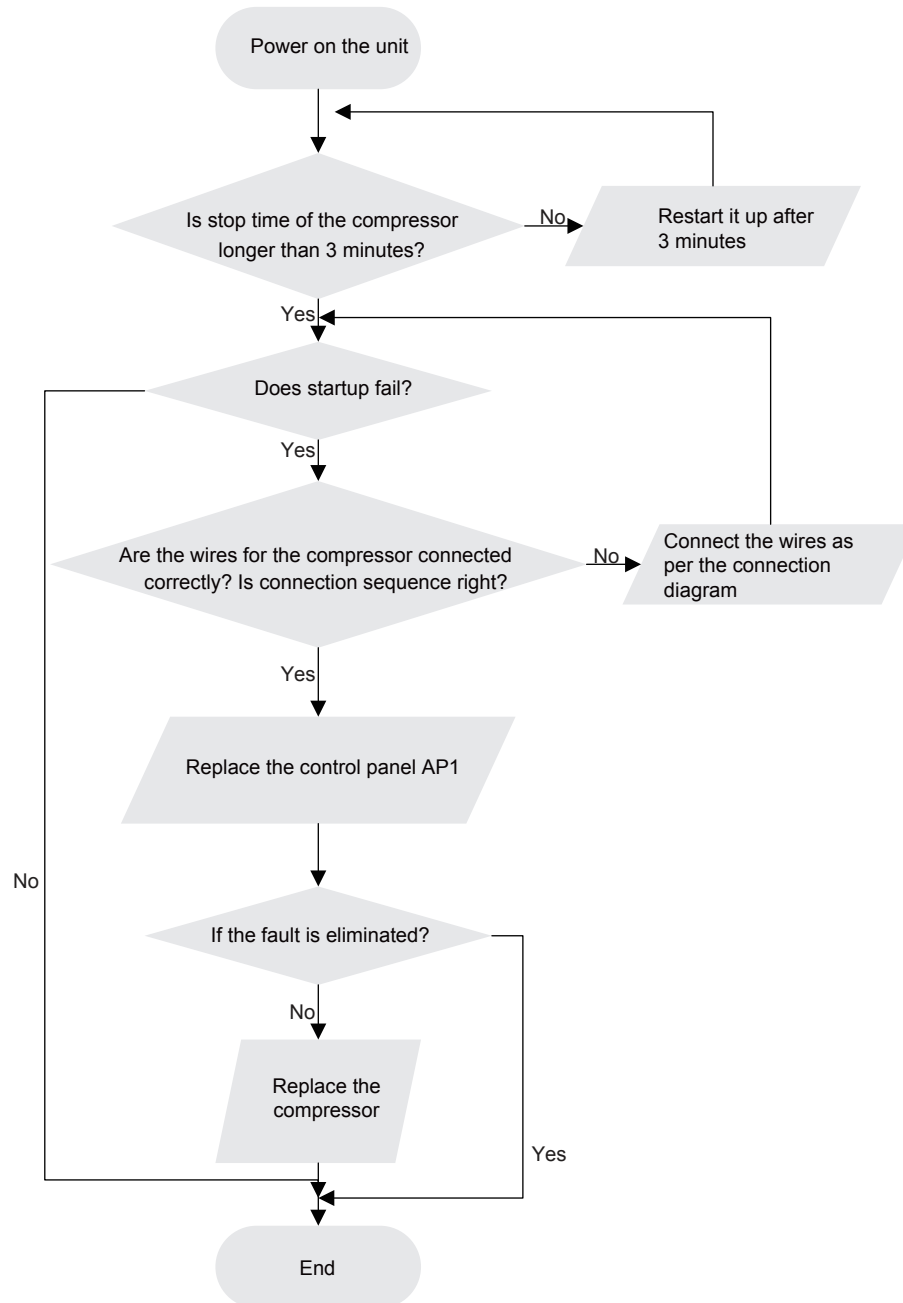

9. Maintenance

5. Desynchronization diagnosis for compressor H7

(AP1 hereinafter refers to the control board of the outdoor unit)

Main detection points:

(1) system pressure (2) power supply voltage

Malfunction diagnosis process:

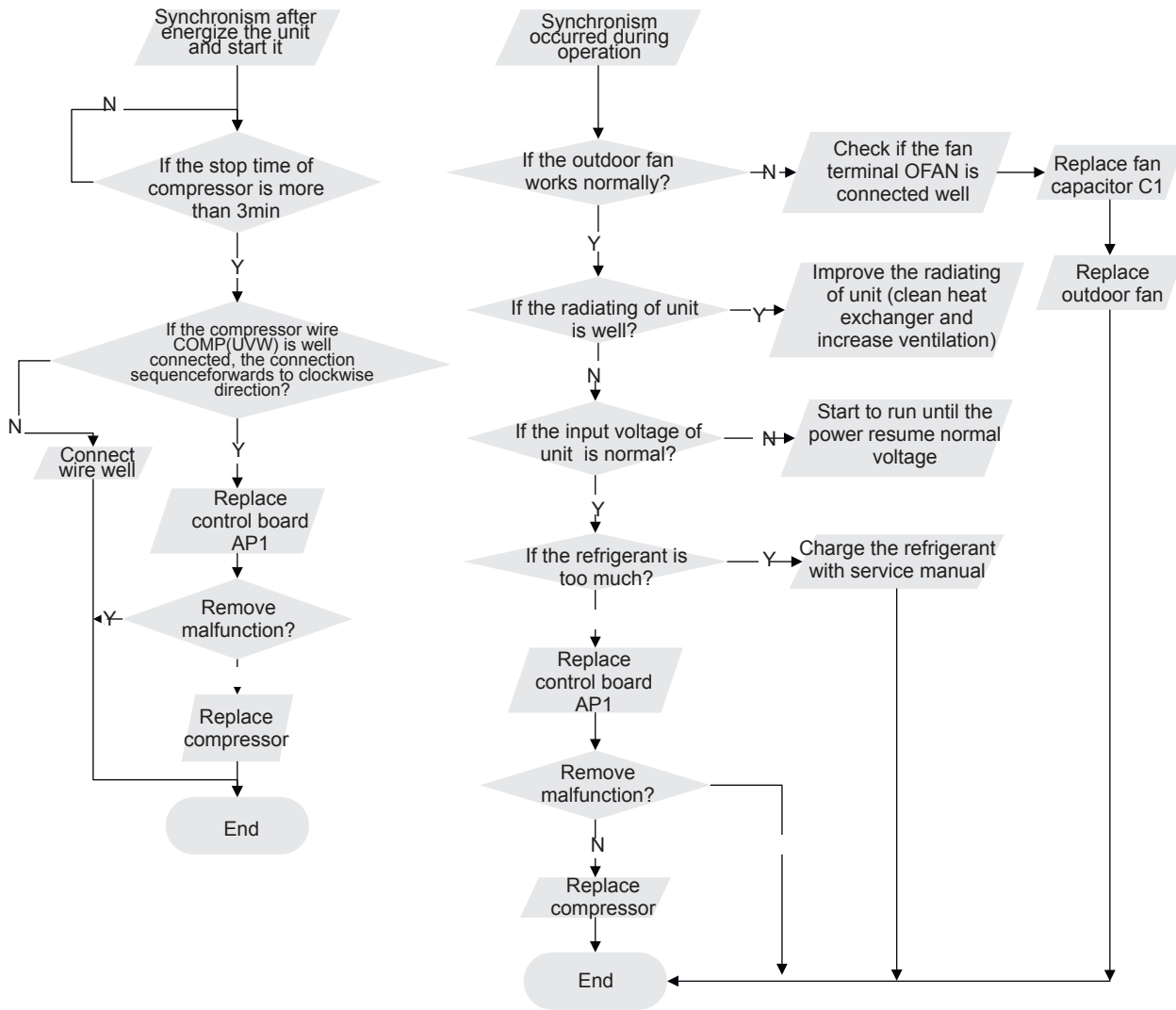

9. Maintenance

6. Overload protection of compressor H3, high discharge temperature protection of compressor E4 (AP1 hereinafter refers to the control board of the outdoor unit)

Main detection points:

(1) electronic expansion valve (2) expansion valve terminal (3) charging amount of refrigerant (4) overload protector

Malfunction diagnosis process:

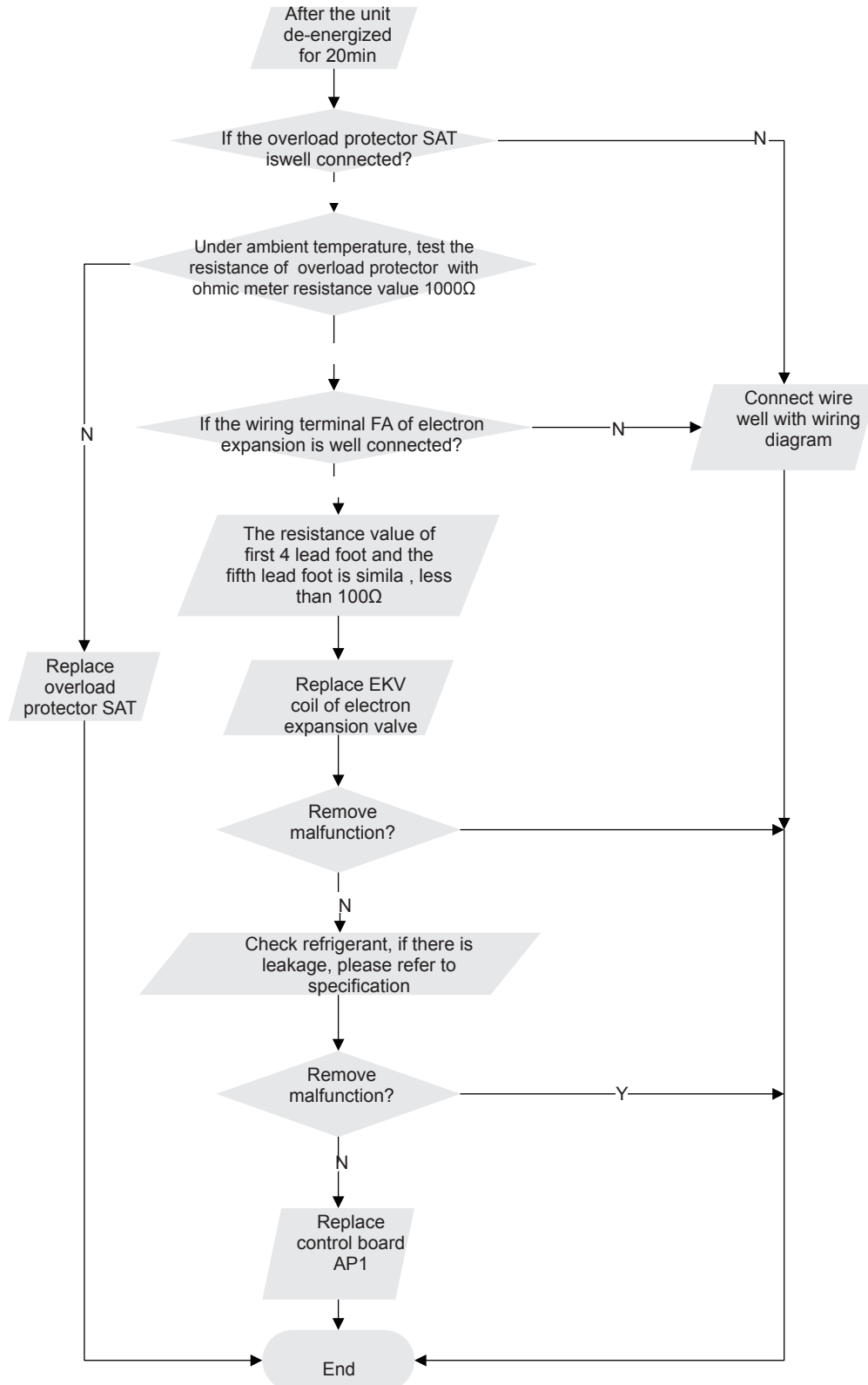

9. Maintenance

7 Communication malfunction: (following AP1 for outdoor unit control board)

Mainly detect:

- Is there any damage for the indoor unit mainboard communication circuit? Is communication circuit damaged?
- Detect the indoor and outdoor units connection wire and indoor and outdoor units inside wiring is connect well or not, if is there any damage?

Fault diagnosis process:

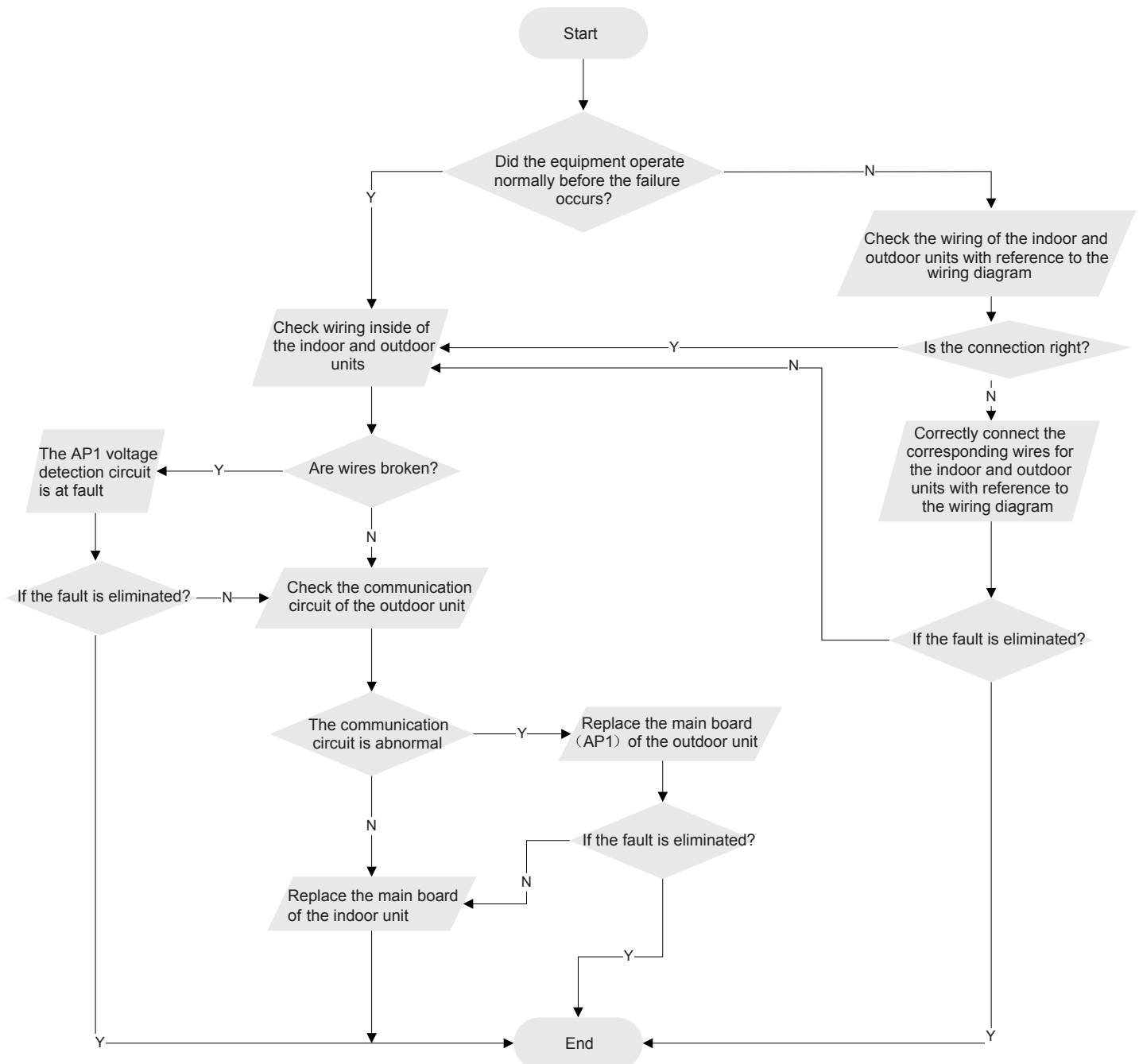

9. Maintenance

8. Overload and high discharge temperature malfunction

Main detection points:

- If the electronic expansion valve is connected well? Is the electronic expansion valve damaged?
- If the refrigerant is leaked?
- The compressor overload protection terminal is not connected well with the mainboard?
- If the overload protector is damaged?
- Heat exchange of unit is not good? (heat exchanger is dirty and unit radiating environment is bad)
- Too much load of the system causes high temperature of compressor after working for a long time?
- Malfunction of discharge temperature sensor?

9. Maintenance

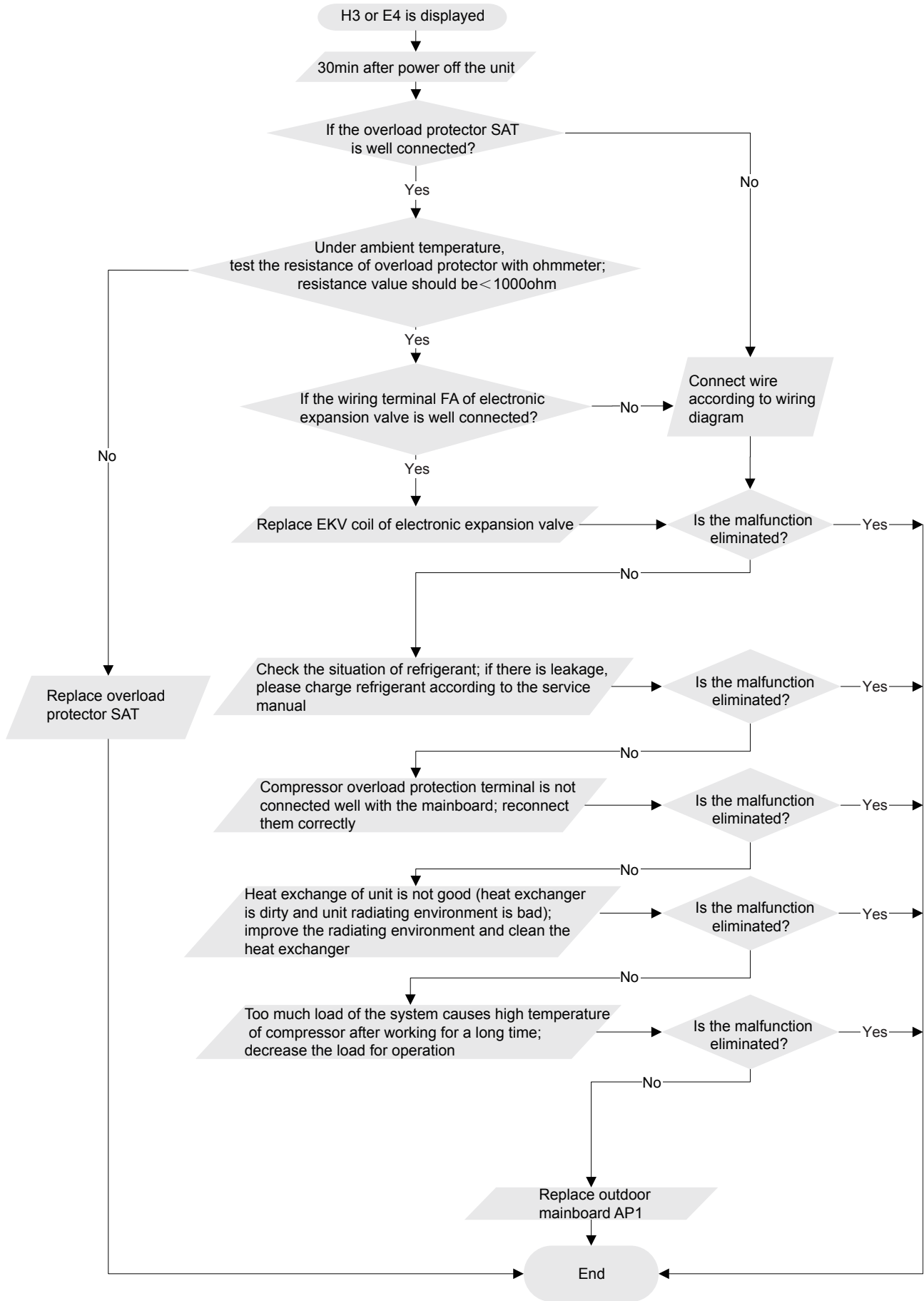

9. Maintenance

9.3 Troubleshooting for Normal Malfunction

1. Air Conditioner can't be Started Up

Possible Causes	Discriminating Method (Air conditioner Status)	Troubleshooting
No power supply, or poor connection for power plug	After energization, operation indicator isn't bright and the buzzer can't give out sound	Confirm whether it's due to power failure. If yes, wait for power recovery. If not, check power supply circuit and make sure the power plug is connected well.
Wrong wire connection between indoor unit and outdoor unit, or poor connection for wiring terminals	Under normal power supply circumstances, operation indicator isn't bright after energization	Check the circuit according to circuit diagram and connect wires correctly. Make sure all wiring terminals are connected firmly
Electric leakage for air conditioner	After energization, room circuit breaker trips off at once	Make sure the air conditioner is grounded reliably Make sure wires of air conditioner is connected correctly Check the wiring inside air conditioner. Check whether the insulation layer of power cord is damaged; if yes, place the power cord.
Model selection for air switch is improper	After energization, air switch trips off	Select proper air switch
Malfunction of remote controller	After energization, operation indicator is bright, while no display on remote controller or buttons have no action.	Replace batteries for remote controller Repair or replace remote controller

2. Poor Cooling (Heating) for Air Conditioner

Possible Causes	Discriminating Method (Air conditioner Status)	Troubleshooting
Set temperature is improper	Observe the set temperature on remote controller	Adjust the set temperature
Rotation speed of the IDU fan motor is set too low	Small wind blow	Set the fan speed at high or medium
Filter of indoor unit is blocked	Check the filter to see it's blocked	Clean the filter
Installation position for indoor unit and outdoor unit is improper	Check whether the installation position is proper according to installation requirement for air conditioner	Adjust the installation position, and install the rainproof and sunproof for outdoor unit
Refrigerant is leaking	Discharged air temperature during cooling is higher than normal discharged wind temperature; Discharged air temperature during heating is lower than normal discharged wind temperature; Units pressure is much lower than regulated range	Find out the leakage causes and deal with it. Add refrigerant.
Malfunction of 4-way valve	Blow cold wind during heating	Replace the 4-way valve
Malfunction of capillary	Discharged air temperature during cooling is higher than normal discharged wind temperature; Discharged air temperature during heating is lower than normal discharged wind temperature; Unit pressure is much lower than regulated range. If refrigerant isn't leaking, part of capillary is blocked	Replace the capillary
Flow volume of valve is insufficient	The pressure of valves is much lower than that stated in the specification	Open the valve completely
Malfunction of horizontal louver	Horizontal louver can't swing	Refer to point 3 of maintenance method for details
Malfunction of the IDU fan motor	The IDU fan motor can't operate	Refer to troubleshooting for H6 for maintenance method in details
Malfunction of the ODU fan motor	The ODU fan motor can't operate	Refer to point 4 of maintenance method for details
Malfunction of compressor	Compressor can't operate	Refer to point 5 of maintenance method for details

3. Horizontal Louver can't Swing

Possible Causes	Discriminating Method (Air conditioner Status)	Troubleshooting
Wrong wire connection, or poor connection	Check the wiring status according to circuit diagram	Connect wires according to wiring diagram to make sure all wiring terminals are connected firmly
Stepping motor is damaged	Stepping motor can't operate	Repair or replace stepping motor
Main board is damaged	Others are all normal, while horizontal louver can't operate	Replace the main board with the same model

9. Maintenance

4. ODU Fan Motor can't Operate

Possible causes	Discriminating method (air conditioner status)	Troubleshooting
Wrong wire connection, or poor connection	Check the wiring status according to circuit diagram	Connect wires according to wiring diagram to make sure all wiring terminals are connected firmly
Capacity of the ODU fan motor is damaged	Measure the capacity of fan capacitor with an universal meter and find that the capacity is out of the deviation range indicated on the nameplate of fan capacitor.	Replace the capacity of fan
Power voltage is a little low or high	Use universal meter to measure the power supply voltage. The voltage is a little high or low	Suggest to equip with voltage regulator
Motor of outdoor unit is damaged	When unit is on, cooling/heating performance is bad and ODU compressor generates a lot of noise and heat.	Change compressor oil and refrigerant. If no better, replace the compressor with a new one

5. Compressor can't Operate

Possible causes	Discriminating method (air conditioner status)	Troubleshooting
Wrong wire connection, or poor connection	Check the wiring status according to circuit diagram	Connect wires according to wiring diagram to make sure all wiring terminals are connected firmly
Capacity of compressor is damaged	Measure the capacity of fan capacitor with an universal meter and find that the capacity is out of the deviation range indicated on the nameplate of fan capacitor.	Replace the compressor capacitor
Power voltage is a little low or high	Use universal meter to measure the power supply voltage. The voltage is a little high or low	Suggest to equip with voltage regulator
Coil of compressor is burnt out	Use universal meter to measure the resistance between compressor terminals and it's 0	Repair or replace compressor
Cylinder of compressor is blocked	Compressor can't operate	Repair or replace compressor

6. Air Conditioner is Leaking

Possible causes	Discriminating method (air conditioner status)	Troubleshooting
Drain pipe is blocked	Water leaking from indoor unit	Eliminate the foreign objects inside the drain pipe
Drain pipe is broken	Water leaking from drain pipe	Replace drain pipe
Wrapping is not tight	Water leaking from the pipe connection place of indoor unit	Wrap it again and bundle it tightly

7. Abnormal Sound and Vibration

Possible causes	Discriminating method (air conditioner status)	Troubleshooting
When turn on or turn off the unit, the panel and other parts will expand and There's abnormal sound	There's the sound of "PAPA"	Normal phenomenon. Abnormal sound will disappear after a few minutes.
When turn on or turn off the unit, There's abnormal sound due to flow of refrigerant inside air conditioner	Water-running sound can be heard	Normal phenomenon. Abnormal sound will disappear after a few minutes.
Foreign objects inside the indoor unit or there're parts touching together inside the indoor unit	There's abnormal sound fro indoor unit	Remove foreign objects. Adjust all parts position of indoor unit, tighten screws and stick damping plaster between connected parts
Foreign objects inside the outdoor unit or there're parts touching together inside the outdoor unit	There's abnormal sound fro outdoor unit	Remove foreign objects. Adjust all parts position of outdoor unit, tighten screws and stick damping plaster between connected parts
Short circuit inside the magnetic coil	During heating, the way valve has abnormal electromagnetic sound	Replace magnetic coil
Abnormal shake of compressor	Outdoor unit gives out abnormal sound	Adjust the support foot mat of compressor, tighten the bolts
Abnormal sound inside the compressor	Abnormal sound inside the compressor	If add too much refrigerant during maintenance, please reduce refrigerant properly. Replace compressor for other circumstances.

10. Exploded View and Parts List

10.1 Indoor Unit

QB Unit:

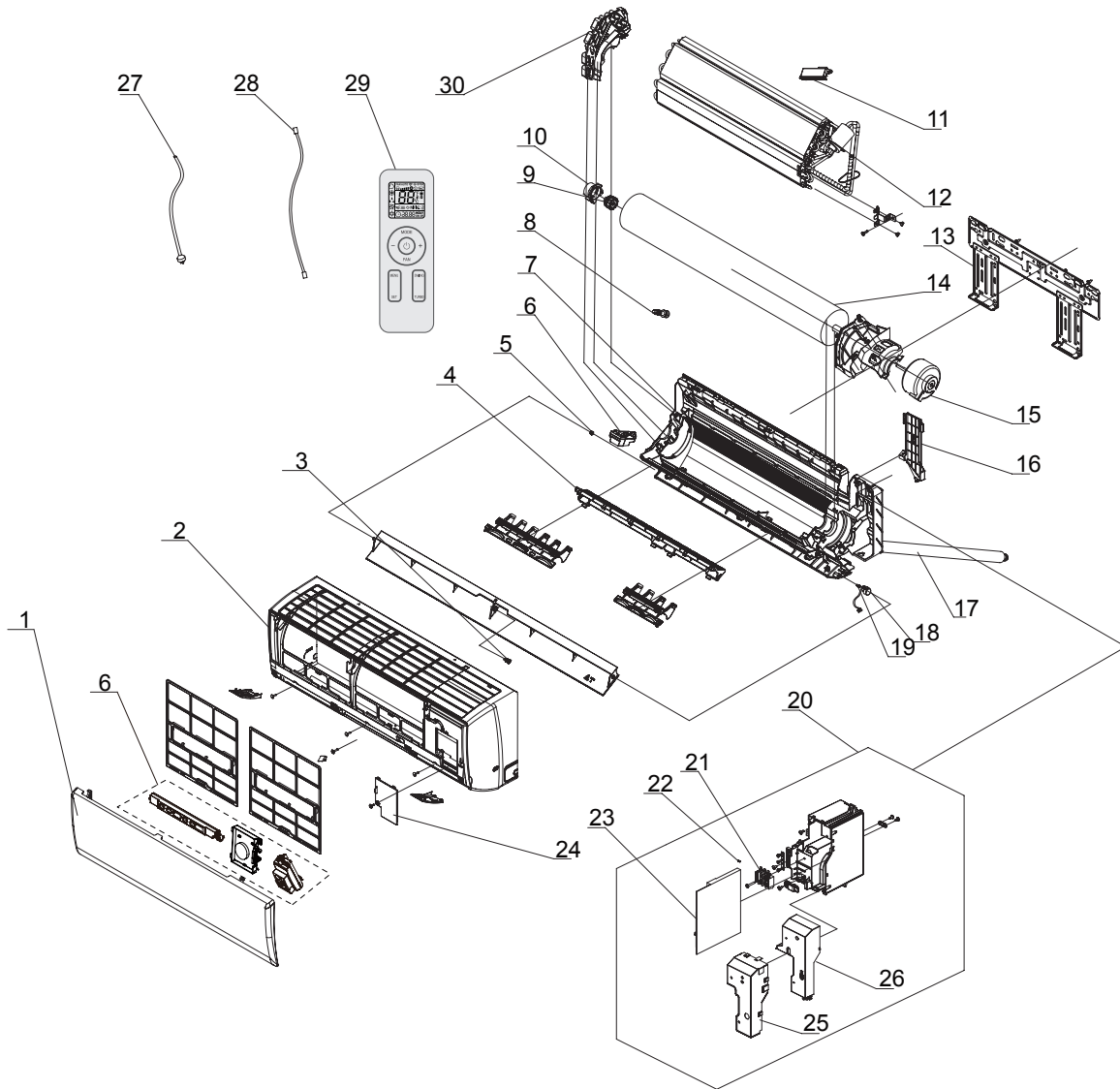

The component picture is only for reference; please refer to the actual product.

No.	Description
1	Front Panel
2	Front Case
3	Axile Bush
4	Helicoid Tongue
5	Left Axile Bush
6	Display Board
7	Rear Case assy
8	Rubber Plug (Water Tray)
9	O-Gasket sub-assy of Bearing
10	Ring of Bearing
11	Cold Plasma Generator
12	Evaporator Assy
13	Wall Mounting Frame
14	Cross Flow Fan
15	Fan Motor

No.	Description
16	Connecting pipe clamp
17	Drainage Hose
18	Stepping Motor
19	Crank
20	Electric Box Assy
21	Terminal Board
22	Jumper
23	Main Board
24	Electric Box Cover Sub-Assy
25	Shield Cover of Electric Box Cover
26	Electric Box Cover
27	Power Cord
28	Connecting Cable
29	Remote Controller
30	Evaporator Support

Some models may not contain some parts, please refer to the actual product.

10. Exploded View and Parts List

QC for Up and down swing Unit:

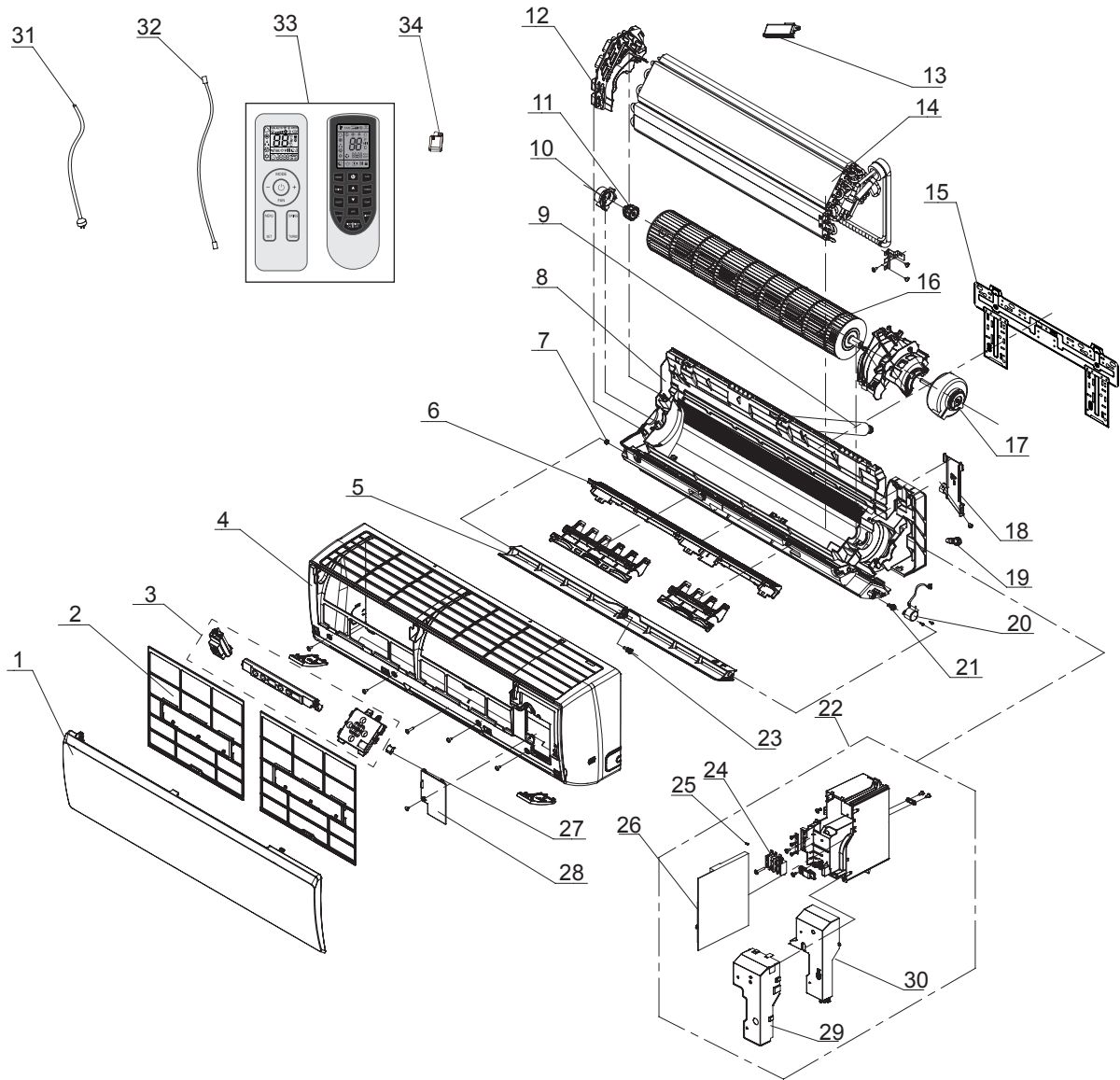

The component picture is only for reference; please refer to the actual product.

NO.	Description
1	Front Panel
2	Filter Sub-Assy
3	Display Board
4	Front Case Assy
5	Guide Louver
6	Helicoid Tongue
7	Left Axile Bush
8	Rear Case assy
9	Drainage Hose
10	Ring of Bearing
11	O-Gasket sub-assy of Bearing
12	Evaporator Supper

NO.	Description
13	Cold Plasma Generator
14	Evaporator Assy
15	Wall Mounting Frame
16	Cross Flow Fan
17	Fan Motor
18	Connecting pipe clamp
19	Rubber Plug (Water Tray)
20	Stepping Motor
21	Crank
22	Electric Box Assy
23	Axile Bush
24	Terminal Board

NO.	Description
25	Jumper
26	Main Board
27	Screw Cover
28	Electric Box Cover Sub-Assy
29	Shield Cover of Electric Box Cover
30	Electric Box Cover
31	Power Cord
32	Connecting Cable
33	Remote Controller
34	Detecting Plate(WIFI)

Some models may not contain some parts, please refer to the actual product.

10. Exploded View and Parts List

QC for four-sided swing unit:

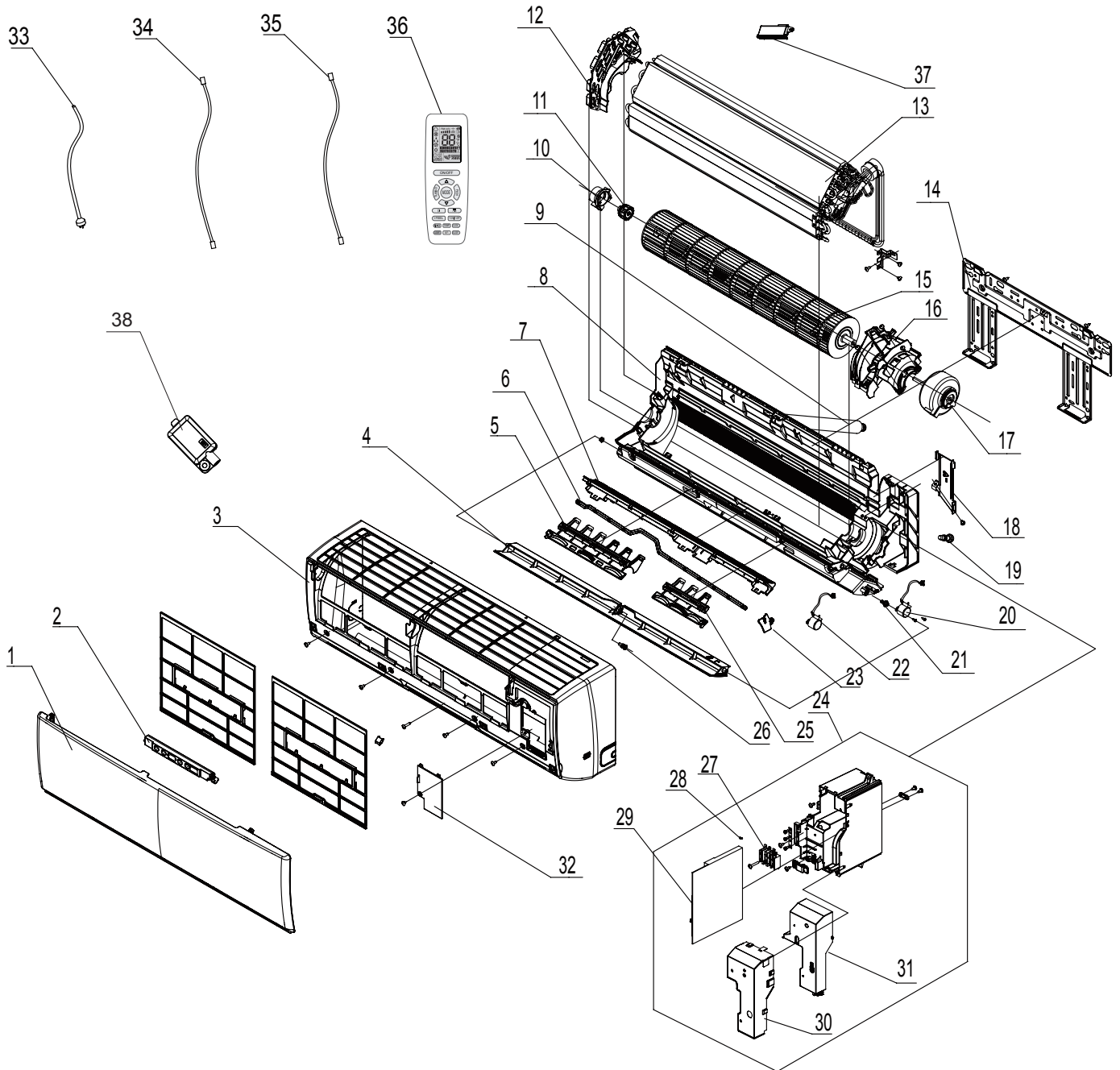

The component picture is only for reference; please refer to the actual product.

10. Exploded View and Parts List

NO.	Description
1	Front Panel Assy
2	Display Board
3	Front Case Assy
4	Guide Louver
5	Air Louver
6	Swing Lever
7	Helicoid Tongue
8	Rear Case
9	Drainage Hose
10	Ring of Bearing
11	O-Gasket sub-assy of Bearing
12	Evaporator Support
13	Evaporator Assy
14	Wall Mounting Frame
15	Cross Flow Fan
16	Motor Press Plate
17	Fan Motor
18	Connecting pipe clamp
19	Rubber Plug (Water Tray)

NO.	Description
20	Stepping Motor
21	Crank
22	Stepping Motor
23	Air Louver
24	Electric Box Assy
25	Air Louver
26	Axile Bush
27	Terminal Board
28	Jumper
29	Main Board
30	Shield Cover of Electric Box Cover
31	Electric Box Cover Sub-Assy
32	Electric Box Cover
33	Power Cord
34	Connecting Cable
35	Connecting Cable
36	Remote Controller
37	Cold Plasma Generator
38	Detecting plate(WIFI)

Some models may not contain some parts, please refer to the actual product.

10. Exploded View and Parts List

QD Unit

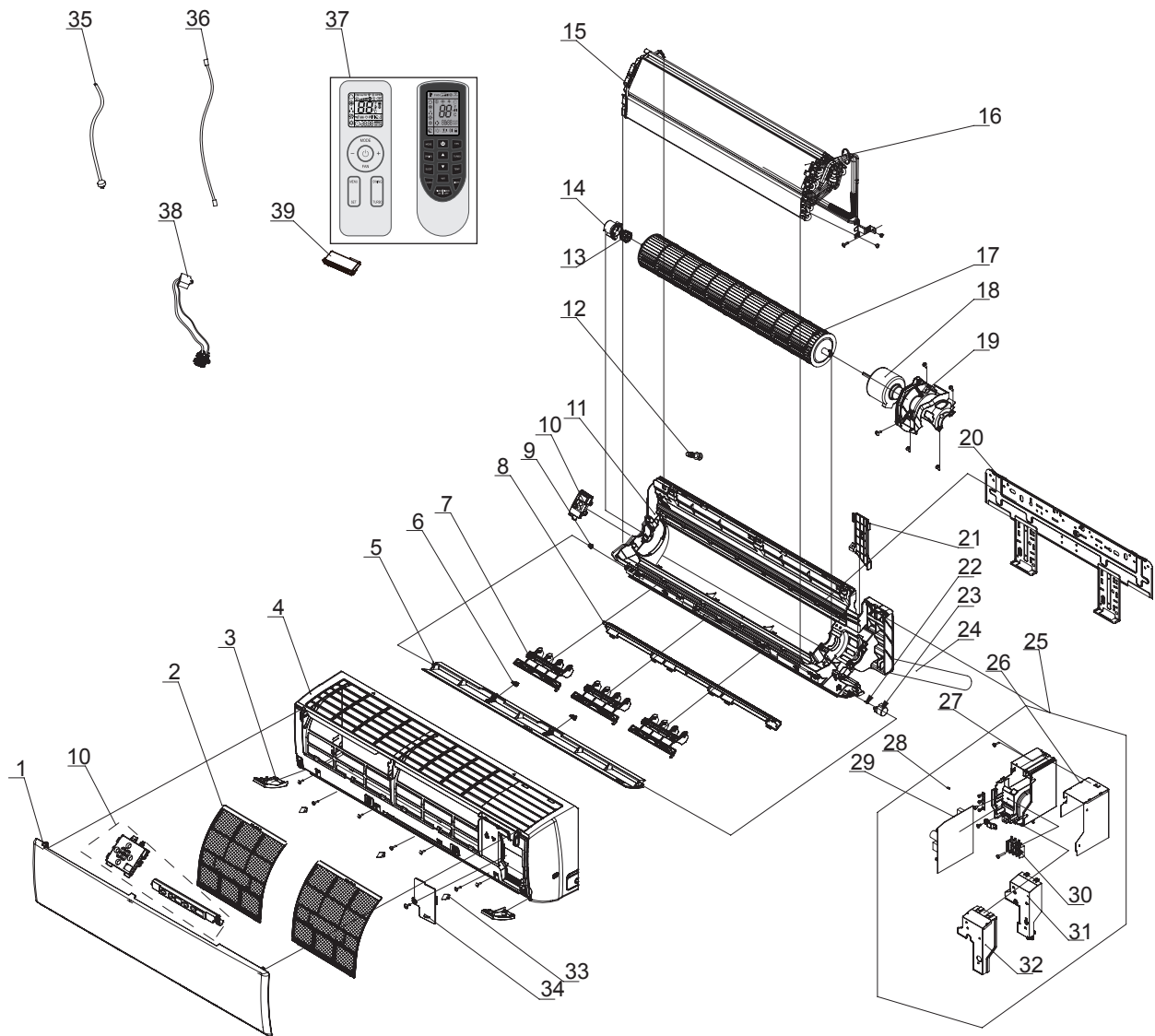

The component picture is only for reference; please refer to the actual product.

NO.	Description
1	Front Panel
2	Filter Sub-Assy
3	Decoration board(left and right)
4	Front Case
5	Guide Louver
6	Axile Bush
7	Air Louver(Manual)
8	Helicoid Tongue
9	Left Axile Bush
10	Display Board
11	Rear Case assy
12	Rubber Plug (Water Tray)
13	O-Gasket sub-assy of Bearing

NO.	Description
14	O-Gasket of Cross Fan Bearing
15	Evaporator Support
16	Evaporator Assy
17	Cross Flow Fan
18	Fan Motor
19	Motor Press Plate
20	Wall Mounting Frame
21	Connecting pipe clamp
22	Crank
23	Stepping Motor
24	Drainage Hose
25	Electric Box Assy
26	Lower Shield of Electric Box

NO.	Description
27	Electric Box
28	Jumper
29	Main Board
30	Terminal Board
31	Electric Box Cover
32	Shield Cover of Electric Box
33	Screw Cover
34	Electric Box Cover2
35	Power Cord
36	Connecting Cable
37	Remote Controller
38	Cold Plasma Generator
39	Detecting plate(WIFI)

Some models may not contain some parts, please refer to the actual product.

10. Exploded View and Parts List

QE for Up and down swing Unit:

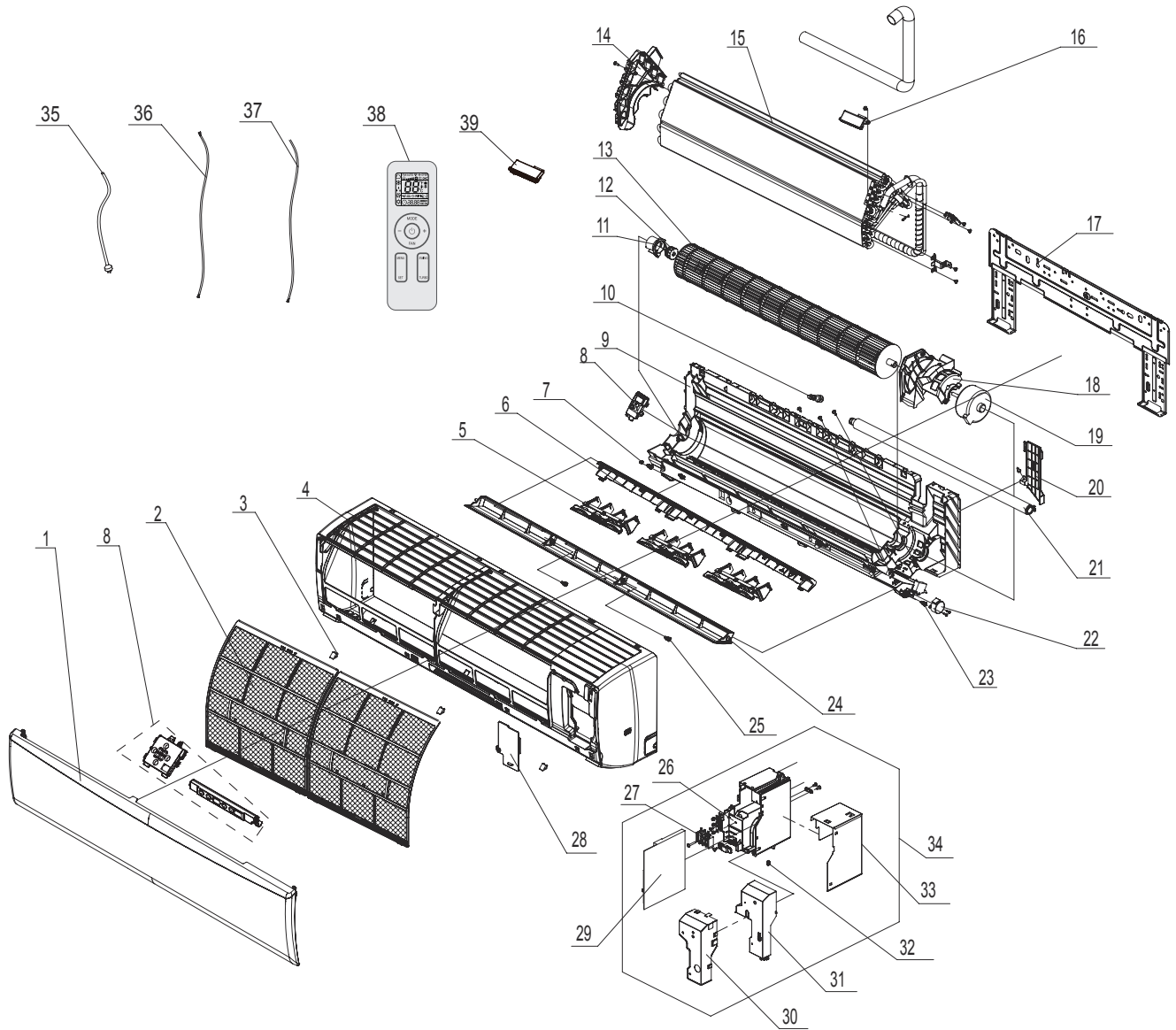

The component picture is only for reference; please refer to the actual product.

NO.	Description
1	Front Panel
2	Filter Sub-Assy
3	Screw Cover
4	Front Case
5	Air Louver(Manual)
6	Helicoid Tongue
7	Left Axile Bush
8	Display Board
9	Rear Case assy
10	Rubber Plug (Water Tray)
11	Ring of Bearing
12	O-Gasket sub-assy of Bearing
13	Cross Flow Fan

NO.	Description
14	Evaporator Support
15	Evaporator Assy
16	Cold Plasma Generator
17	Wall Mounting Frame
18	Motor Press Plate
19	Fan Motor
20	Connecting pipe clamp
21	Drainage Hose
22	Stepping Motor
23	Crank
24	Guide Louver
25	Axile Bush
26	Electric Box

NO.	Description
27	Terminal Board
28	Electric Box Cover2
29	Main Board
30	Shield Cover of Electric Box
31	Electric Box Cover
32	Jumper
33	Lower Shield of Electric Box
34	Electric Box Assy
35	Power Cord
36	Connecting Cable
37	Temperature Sensor
38	Remote Controller
39	Detecting plate(WIFI)

Some models may not contain some parts, please refer to the actual product.

10. Exploded View and Parts List

QE for four-sided swing unit:

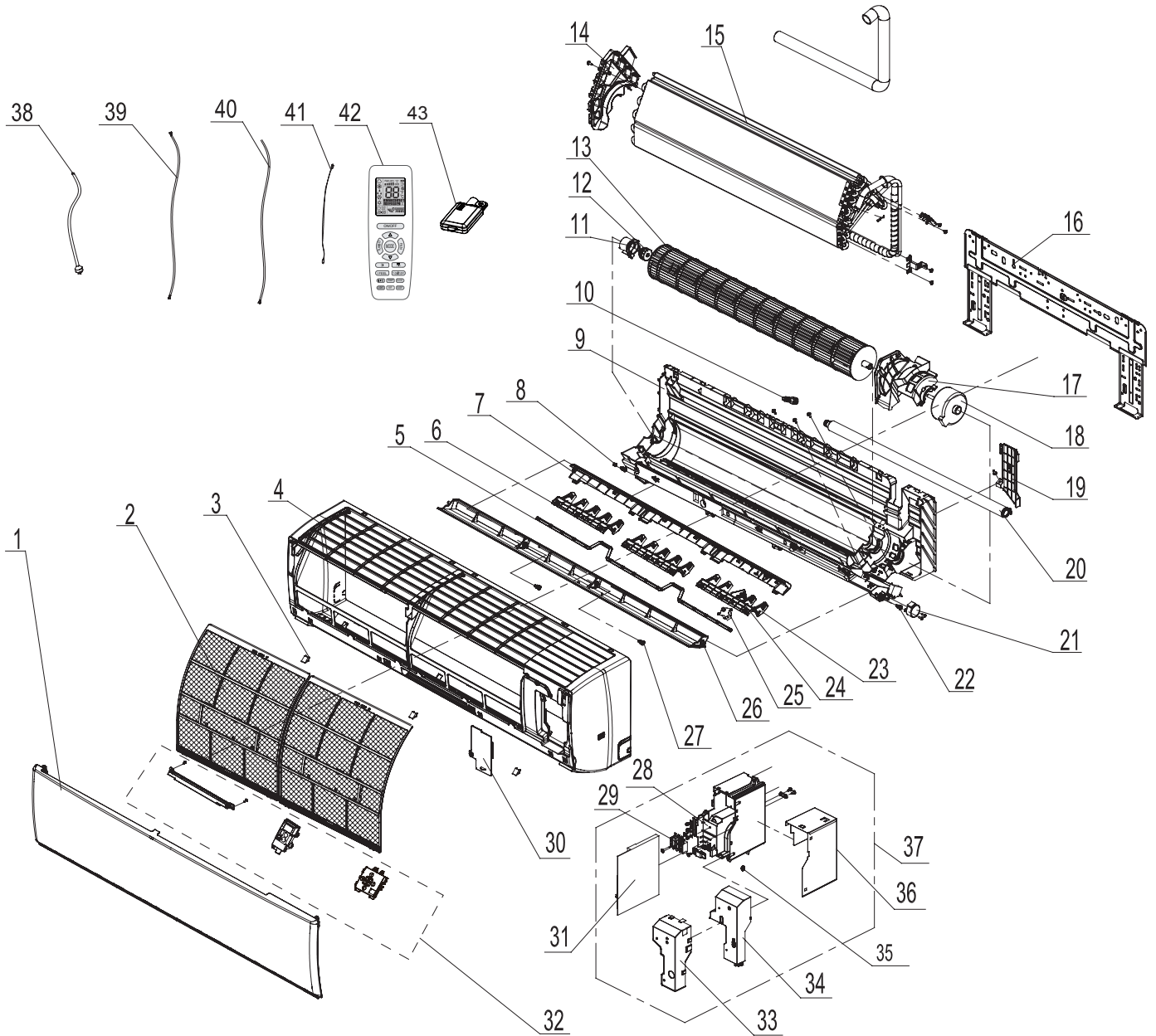

The component picture is only for reference; please refer to the actual product.

10. Exploded View and Parts List

No.	Description
1	Front Panel Assy
2	Filter Sub-Assy
3	Screw Cover
4	Front Case Assy
5	Swing Lever
6	Air Louver
7	Helicoid Tongue sub-assy
8	Left Axile Bush
9	Rear Case assy
10	Rubber Plug (Water Tray)
11	Ring of Bearing
12	O-Gasket sub-assy of Bearing
13	Cross Flow Fan
14	Evaporator Support
15	Evaporator Assy
16	Wall Mounting Frame
17	Motor Press Plate
18	Fan Motor
19	Connecting pipe clamp
20	Drainage Hose
21	Stepping Motor
22	Crank

No.	Description
23	Air Louver 1
24	Air Louver 1
25	Stepping Motor
26	Guide Louver
27	Axile Bush
28	Electric Box
29	Terminal Board
30	Electric Box Cover 2
31	Main Board
32	Display Board
33	Shield Cover of Electric Box
34	Electric Box Cover
35	Jumper
36	Lower Shield of Electric Box
37	Electric Box Assy
38	Power Cord
39	Connecting Cable
40	Connecting Cable
41	Temperature Sensor
42	Remote Controller
43	Detecting Plate

Some models may not contain some parts, please refer to the actual product.

10. Exploded View and Parts List

10.2 Outdoor Unit

GWH09QBXB-A3DNC4B/O GWH09QBXB-D3DNC4B/O GWH12QCXB-D3DNC4B/O GRHFRT12ASAO

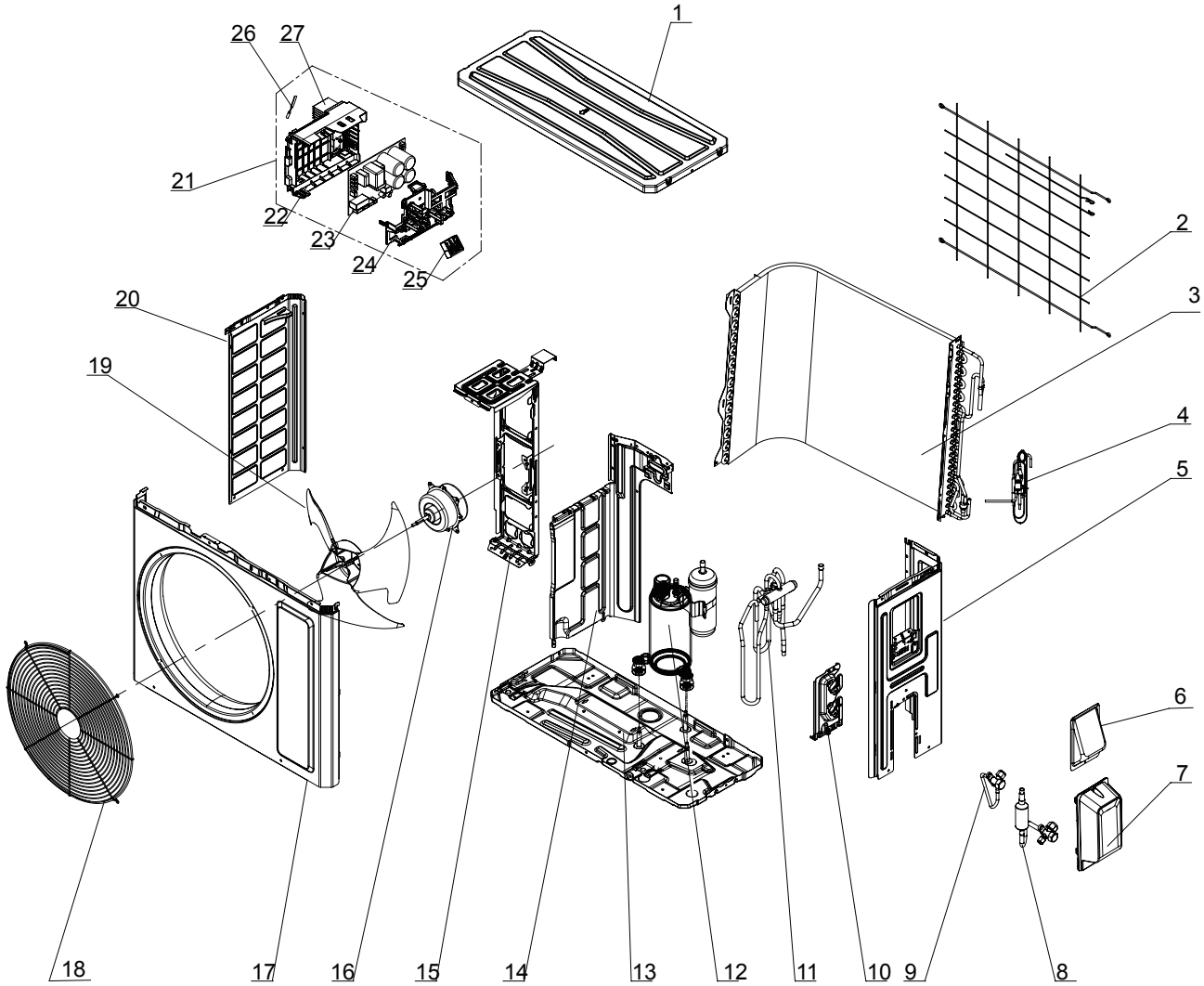

The component picture is only for reference; please refer to the actual product.

NO.	Description
1	Coping
2	Rear Grill
3	Condenser Assy
4	Capillary Sub-Assy
5	Right Side Plate
6	Cover of Pass Wire
7	Valve Cover
8	Cut-off valve Sub-Assy
9	Cut-off valve

NO.	Description
10	Valve Support
11	4-way valve assy
12	Compressor and Fittings
13	Chassis Sub-Assy
14	Clapboard
15	Motor Support
16	Brushless DC Motor
17	Cabinet
18	Front Grill

NO.	Description
19	Axial Flow Fan
20	Left Side Plate
21	Electric Box Assy
22	Electric Box
23	Main Board
24	Electric Box Cover
25	Terminal Board
26	Temperatue Sensor
27	Radiator

Some models may not contain some parts, please refer to the actual product.

10. Exploded View and Parts List

GWC09QBXB-A3DNC4B/O GWC09QBXB-D3DNC4B/O GWC12QCXB-D3DNC4B/O GWC12QCXB-A3DNC4B/O

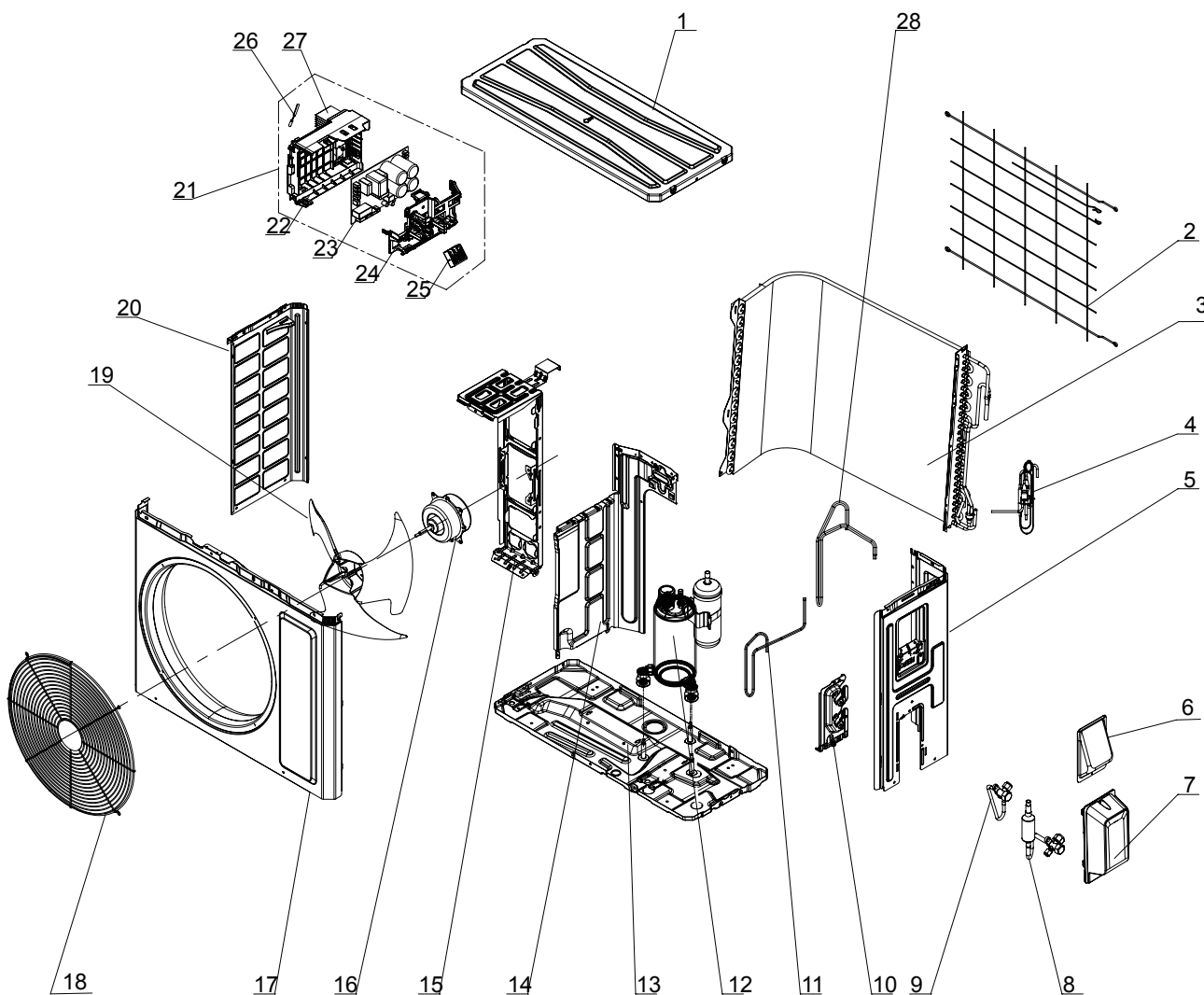

The component picture is only for reference; please refer to the actual product.

NO.	Description
1	Coping
2	Rear Grill
3	Condenser Assy
4	Capillary Sub-Assy
5	Right Side Plate
6	Cover of Pass Wire
7	Valve Cover
8	Cut-off valve Sub-Assy
9	Cut-off valve
10	Valve Support

NO.	Description
11	Discharge Tube
12	Compressor and Fittings
13	Chassis Sub-Assy
14	Clapboard
15	Motor Support
16	Brushless DC Motor
17	Cabinet
18	Front Grill
19	Axial Flow Fan
20	Left Side Plate

NO.	Description
21	Electric Box Assy
22	Electric Box
23	Main Board
24	Electric Box Cover
25	Terminal Board
26	Temperatue Sensor
27	Radiator
28	Inhalation Tube

Some models may not contain some parts, please refer to the actual product.

10. Exploded View and Parts List

GWH09QCXB-A3DND4B/O GWH09QCXB-D3DND4B/O GWHFRT12SAO GWHFRT12S O

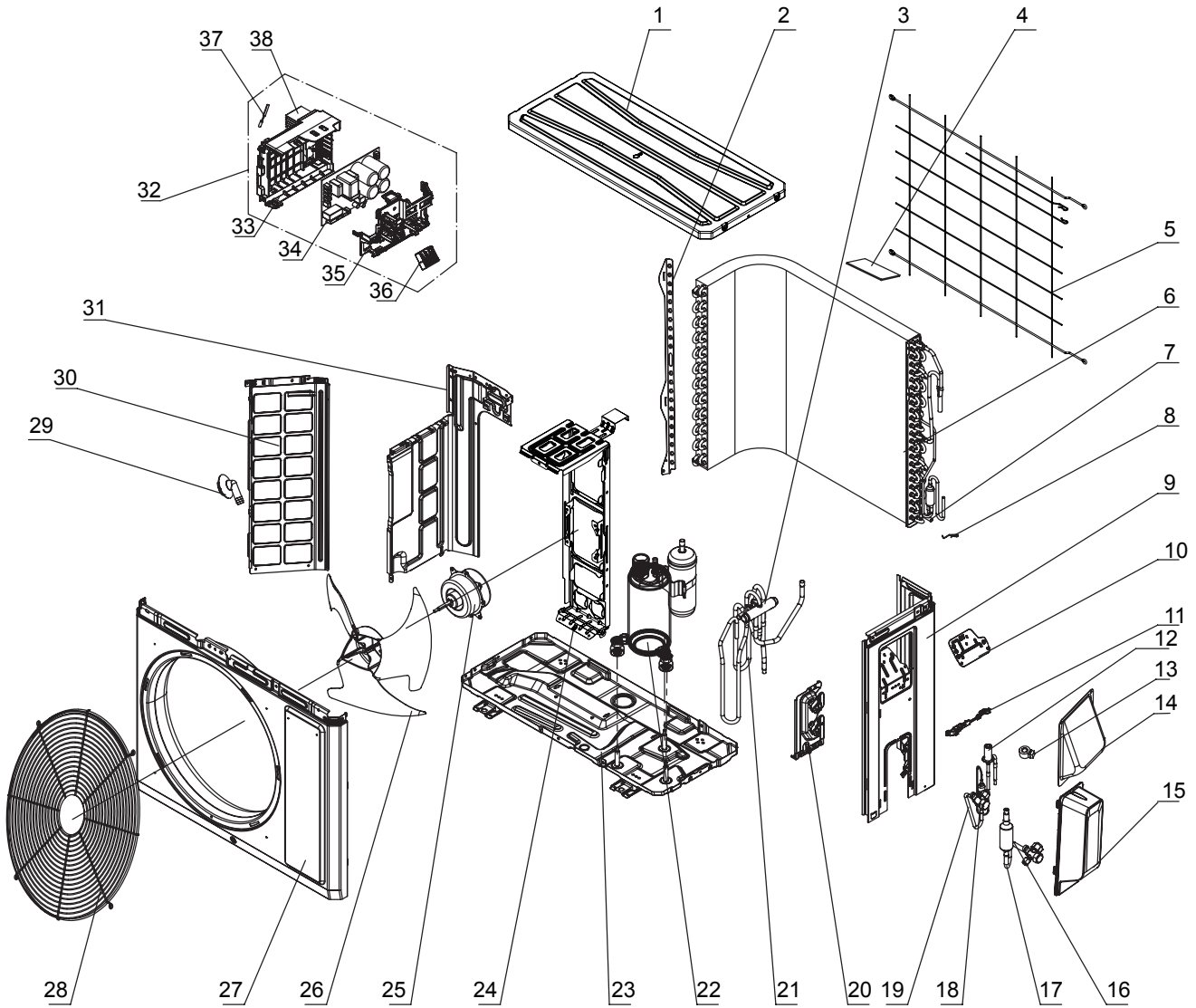

The component picture is only for reference; please refer to the actual product.

NO.	Description
1	Top Cover Assy
2	Condenser Left Border Plate
3	4-Way Valve
4	Sponge(Condenser)
5	Rear Grill
6	Condenser Assy
7	Temp Sensor Sleeving
8	Sensor Insert
9	Right Side Plate
10	Earthing Plate Subassy
11	Wire Clamp
12	Electronic Expansion Valve
13	Electric Expand Valve Fitting

NO.	Description
14	Cable Cross Plate
15	Valve Cover
16	Silencer
17	Cut off Valve Sub-Assy
18	Strainer
19	Cut-off valve 1/4(N)
20	Valve Support
21	4-Way Valve Assy
22	Compressor and Fittings
23	Chassis Sub-assy
24	Motor Support
25	Brushless DC Motor
26	Axial Flow Fan

NO.	Description
27	Cabinet
28	Front Grill
29	Drainage Joint
30	Left Side Plate
31	Clapboard
32	Electric Box Assy
33	Electric Box
34	Main Board
35	Electric Box Cover
36	Terminal Board
37	Temperature Sensor
38	Radiator

Some models may not contain some parts, please refer to the actual product.